

OPTIONAL CRF-320

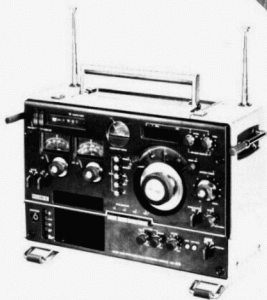

US Model
Canadian Model
E Model
AEP Model
UK Model

FM/SW/MW/LW 32-BAND RADIO RECEIVER

SPECIFICATIONS

Frequency Range:	FM: 87.5–108 MHz (3.43–2.78 m) SW: 1.6–30 MHz (187–10 m) MW: 530–1,605 kHz (566–187 m) LW: 150–400 kHz (2,000–750 m)	Selectivity:	FM: Better than 70 dB (± 400 kHz off resonance) SW/MW/LW: –60 dB at NORMAL (± 8 kHz off resonance) –50 dB at NARROW (± 6 kHz off resonance)
Antennas:	FM: Telescopic antenna, external antenna terminals (75 Ω) SW: Telescopic antenna, external antenna terminals (50–75 Ω) MW/LW: Built-in ferrite-rod antenna, external antenna terminals (high impedance)	Speaker:	12 cm (4 $\frac{3}{4}$ inches) dia.
Intermediate Frequency:	FM: 10.7 MHz, MW/LW: 455 kHz SW-1st: 45.145 MHz, SW-2nd: 455 kHz	Clock:	QUARTZ clock
Sensitivity:	FM: 1.8 μ V (5 dB), S/N – 30 dB SW: 0.7 μ V (–3 dB), S/N – 6 dB, at 10 MHz MW: 32 μ V/m (30 dB/m), S/N = 6 dB, built-in ferrite-rod antenna LW: 57 μ V/m (35 dB/m), S/N = 6 dB, built-in ferrite-rod antenna	Input:	AUX IN (mini jack) 1 Maximum sensitivity 4.4 mV (–45 dB) at 50 mW output Input impedance 5 k Ω
Image Rejection:	FM: 60 dB, at 104 MHz SW: 1st: 90 dB, 2nd: 65 dB, at 10 MHz MW: 55 dB, at 1,605 kHz LW: 80 dB, at 360 kHz	Outputs:	Earphone (mini jack) 1 For 8 Ω earphone HEADPHONES (phone jack) . 1 For 8 Ω headphones Recording (mini jack) 1 Output level 0.8 mV (–60 dB) Output impedance 1 k Ω
		Control Jack:	TIMER OUT (mini jack) 1

– Continued on next page –

SAFETY RELATED COMPONENT WARNING!!

COMPONENTS IDENTIFIED BY SHADING ON THE SCHEMATIC DIAGRAMS AND IN THE PARTS LIST ARE CRITICAL TO SAFE OPERATION. REPLACE THESE COMPONENTS WITH SONY PARTS WHOSE PART NUMBERS APPEAR AS SHOWN IN THIS MANUAL OR IN SUPPLEMENTS PUBLISHED BY SONY.

SONY

SERVICE MANUAL

Power Requirements: Radio: 120 V ac (adjustable to 100, 220 or 240 V at Sony service station) (US, Canadian model)
100-110, 115-127, 200-220 or 230-250 V ac (E model)
110, 127, 220 or 240 V ac (AEP model)
240 V ac (adjustable to 110, 127 or 220 V at the authorized Sony personnel) (UK model)
12 V dc, eight size-D* batteries
12 V car battery with Sony Car Battery Cord DCC-9 (optional)
Clock: 1.5 V dc, one size-D* battery
*IEC designation: R20

Power Consumption: 10 W ac (US, Canadian model)
12 W ac (AEP, UK, E model)

Current Drain: FM/MW/LW: 75 mA, SW: 250 mA, at zero signal, dc
FM/LW/MW: 310 mA, SW: 500 mA, at 2000 mW output, dc

Dimensions: Approx. 451 (w) x 308 (h) x 207 (d) mm
17 3/4 (w) x 12 1/8 (h) x 8 1/8 inches (including projecting parts and controls with the Carrying Handle pushed down)

Weight: Approx. 13 kg, 28 lb 11 oz (including batteries)

MODEL IDENTIFICATION

- Specification Label

US model

SONY® WORLD ZONE MODEL NO. CRF-320
FM/SW/MW/LW 32 BAND RADIO RECEIVER
FREQ. RANGE: FM87.5-108MHz LW150-400kHz
MW530-1605kHz SW1.6-30.0MHz (29 BANDS)
IF: FM10.7MHz SW-1st 45.145MHz 2nd 455kHz
MW, LW455kHz
BATT. SUPPLY: 1.5V x 8 USE SIZE "D" STANDARD
FLASHLIGHT BATT. OR EQUIV.
EXT. DC POWER SUPPLY: 12 V 700 mA
AC POWER SUPPLY: 120 V 10W 60Hz
CLOCK, QUARTZ CLOCK CRYSTAL FREQ 32.768kHz
BATT. SUPPLY 1.5V x 1 USE SIZE "D" STANDARD
FLASHLIGHT BATT. OR EQUIV.
SERIAL NO.

CAUTION: TO PREVENT ELECTRIC SHOCK, DO NOT REMOVE COVER. NO USER-SERVICEABLE PARTS INSIDE. REFER SERVICING TO QUALIFIED SERVICE PERSONNEL.
CERTIFICATION DESIGN CERTIFIED AS COMPLYING WITH F.C.C. RULES PART 15, IN EFFECT AS OF DATE OF MANUFACTURE. MADE IN

Canadian model

SONY® WORLD ZONE MODEL NO. CRF-320
FM/SW/MW/LW 32 BAND RADIO RECEIVER
FREQ. RANGE: FM87.5-108MHz LW150-400kHz
MW530-1605kHz SW1.6-30.0MHz (29 BANDS)
IF: FM10.7MHz SW-1st 45.145MHz 2nd 455kHz
MW, LW455kHz
BATT. SUPPLY: 1.5V x 8 USE SIZE "D" STANDARD
FLASHLIGHT BATT. OR EQUIV.
EXT. DC POWER SUPPLY: 12 V 700 mA
AC POWER SUPPLY: 120 V 10W 60Hz
CLOCK, QUARTZ CLOCK CRYSTAL FREQ. 32.768kHz
BATT. SUPPLY 1.5V x 1 USE SIZE "D" STANDARD
FLASHLIGHT BATT. OR EQUIV.
SERIAL NO.

CAUTION: TO PREVENT ELECTRIC SHOCK, DO NOT REMOVE COVER. NO USER-SERVICEABLE PARTS INSIDE. (LAMPS SOLDERED IN PLACE) REFER SERVICING TO QUALIFIED SERVICE PERSONNEL. MADE IN

E model

SONY® WORLD ZONE MODEL NO. CRF-320
FM/SW/MW/LW 32 BAND RADIO RECEIVER
FREQ. RANGE: FM87.5-108MHz LW150-400kHz
MW530-1605kHz SW1.6-30.0MHz (29 BANDS)
IF: FM10.7MHz SW-1st 45.145MHz 2nd 455kHz
MW, LW455kHz
BATT. SUPPLY: 1.5V x 8 USE SIZE "D" STANDARD
FLASHLIGHT BATT. OR EQUIV.
EXT. DC POWER SUPPLY: 12 V 700 mA
AC POWER SUPPLY: 100-110V, 115-127V
200-220 V, 230-250 V 12W 50/60Hz
CLOCK, QUARTZ CLOCK CRYSTAL FREQ. 32.768kHz
BATT. SUPPLY 1.5V x 1 USE SIZE "D" STANDARD
FLASHLIGHT BATT. OR EQUIV.
SERIAL NO. MADE IN

AEP, UK model

SONY® WORLD ZONE MODEL NO. CRF-320
FM/SW/MW/LW 32 BAND RADIO RECEIVER
FREQ. RANGE: FM87.5-108MHz LW150-400kHz
MW530-1605kHz SW1.6-30.0MHz (29 BANDS)
IF: FM10.7MHz SW-1st 45.145MHz 2nd 455kHz
MW, LW455kHz
BATT. SUPPLY: 12V --- USE SIZE "D" STANDARD
FLASHLIGHT BATT. OR EQUIV.
EXT. POWER SUPPLY: 12 V --- 700 mA
POWER SUPPLY: 110, 127, 220, 240V ~50/60Hz 12W
CLOCK, QUARTZ CLOCK CRYSTAL FREQ 32.768kHz
BATT. SUPPLY 1.5V --- USE SIZE "D" STANDARD
FLASHLIGHT BATT. OR EQUIV.
SERIAL NO.

CAUTION: TO PREVENT ELECTRIC SHOCK, DO NOT REMOVE COVER. NO USER-SERVICEABLE PARTS INSIDE. (LAMPS SOLDERED IN PLACE) REFER SERVICING TO QUALIFIED SERVICE PERSONNEL. MADE IN

SECTION 1
BLOCK DIAGRAM

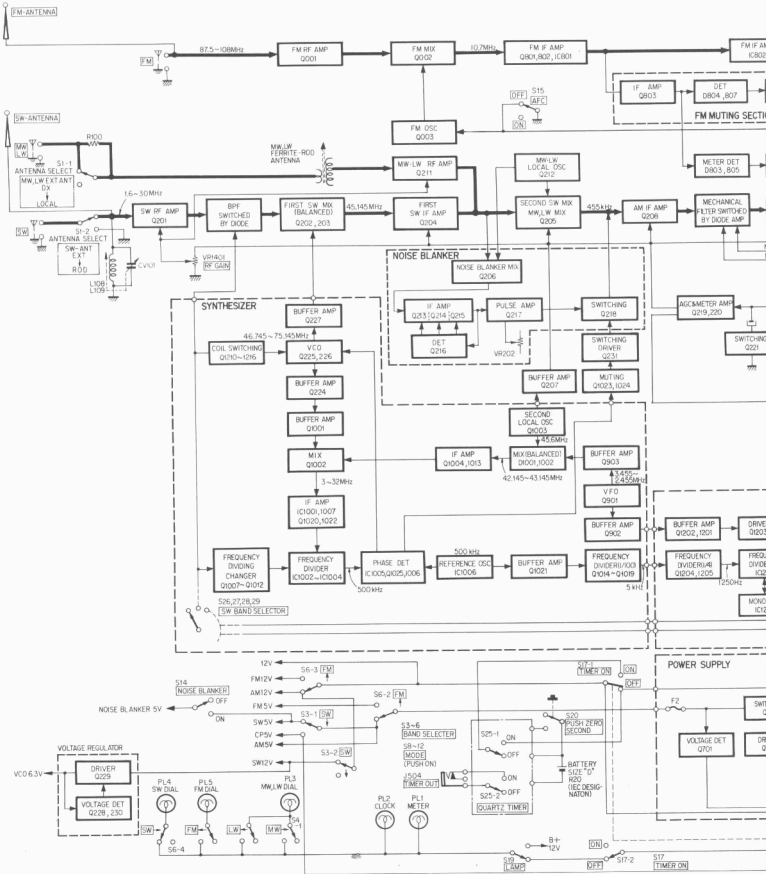

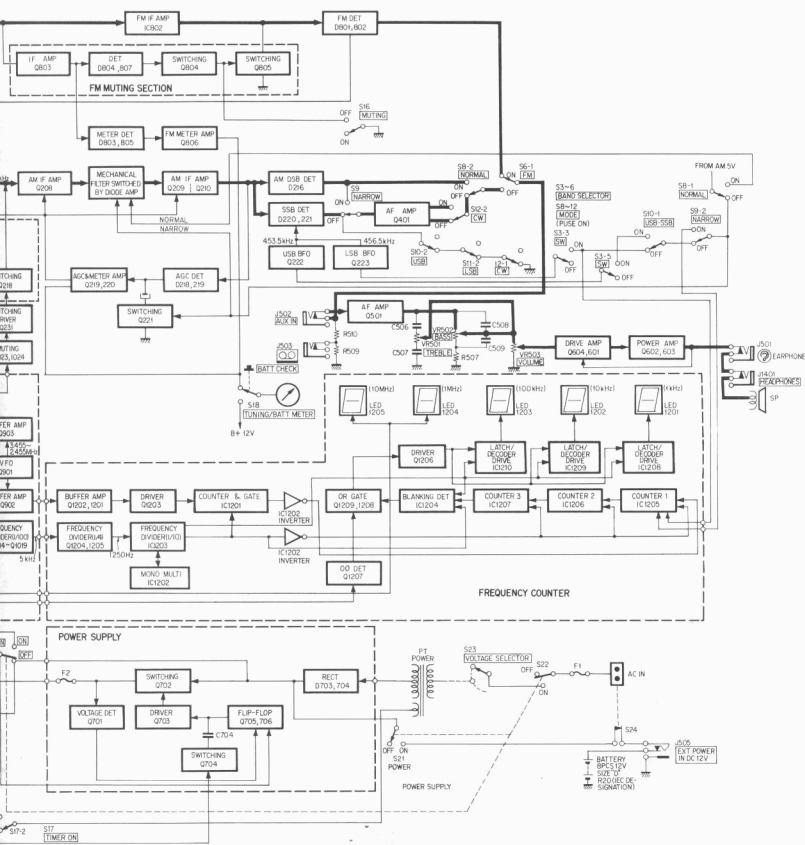

SECTION 2

DISASSEMBLY

2.1. DISASSEMBLY FLOW CHART

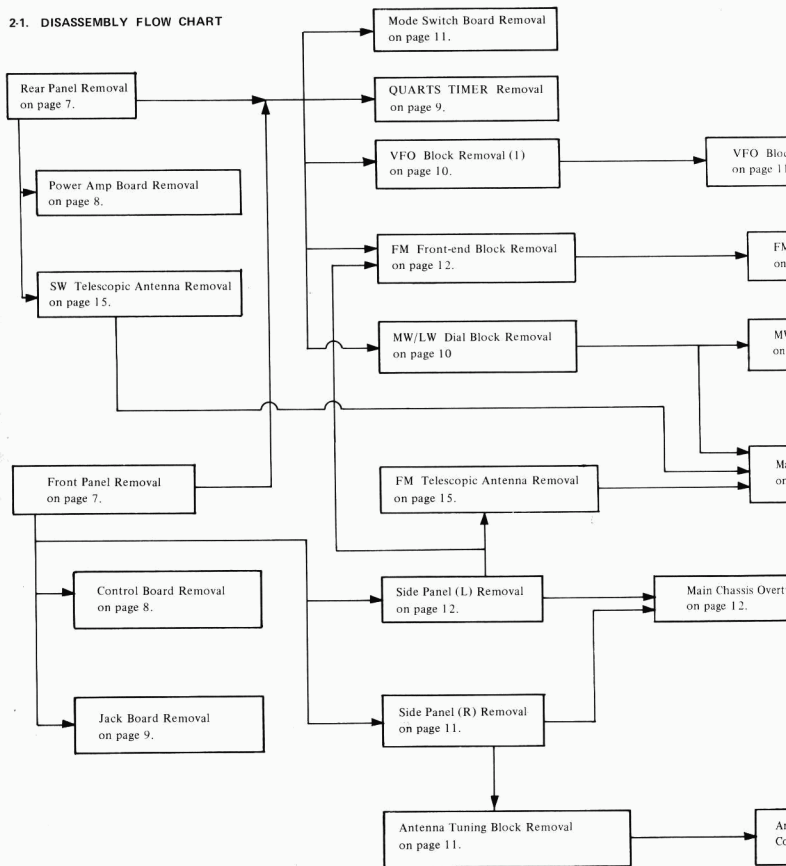

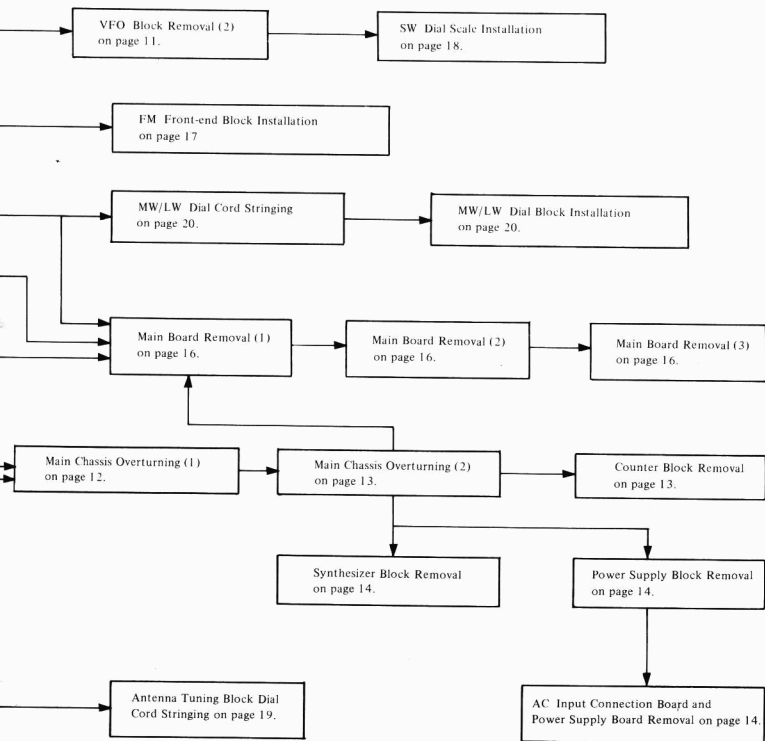

2.2. STEP-BY-STEP DISASSEMBLY

Rear Panel Removal

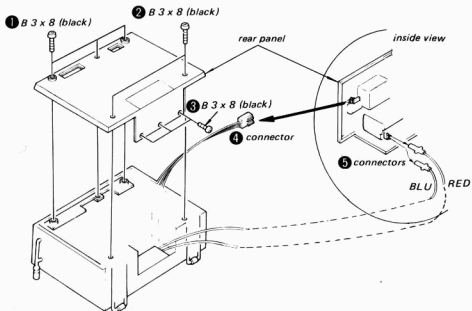

Front Panel Removal

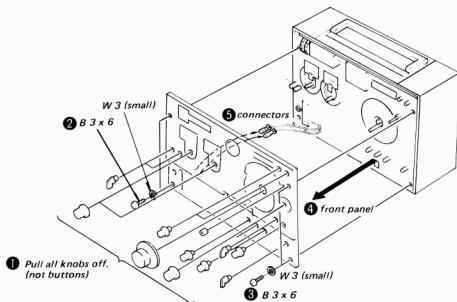

Power Amp Board Removal

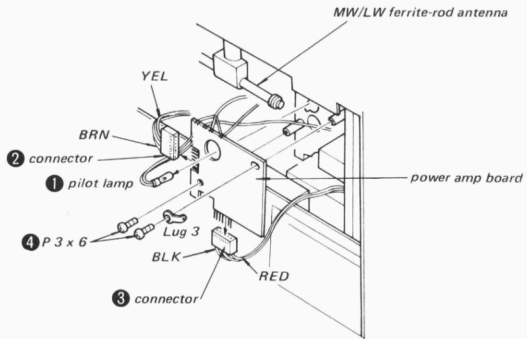
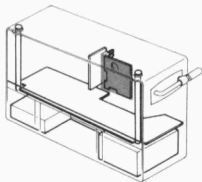

Ⓐ SW Telescopic Antenna Removal on page 15.

Control Board Removal

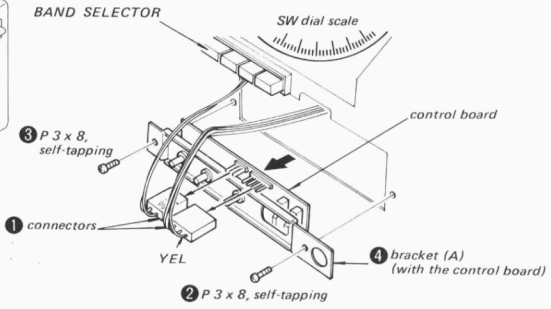
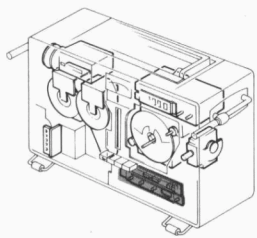

QUARTZ TIMER Removal

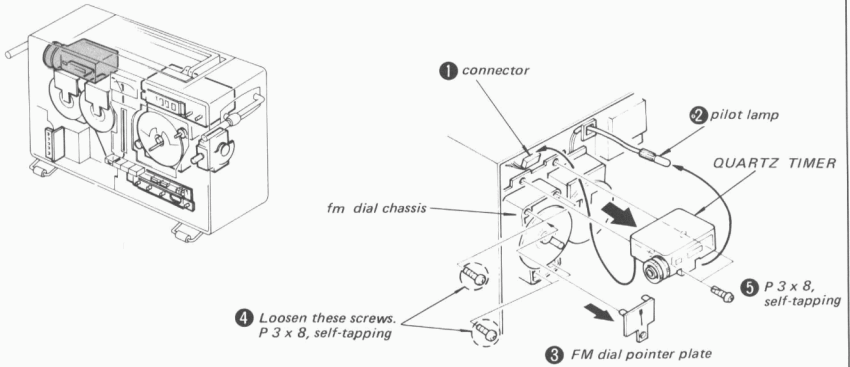

Jack Board Removal

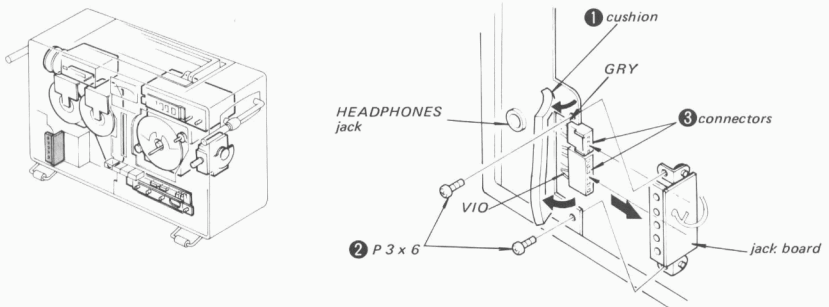

VFO Block Removal (1)

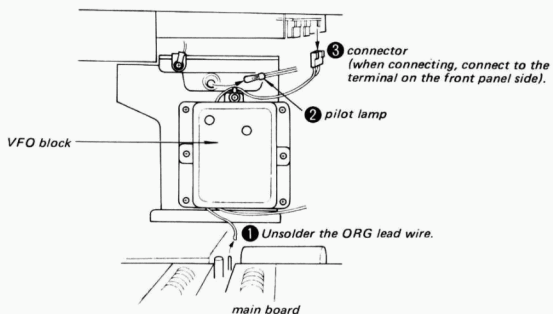

MW/LW Dial Block Removal

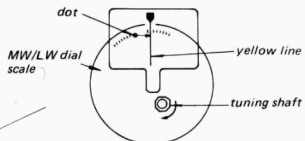
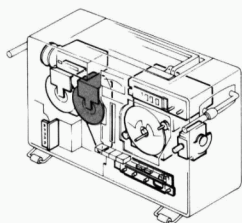

Note: After installing the MW/LW dial scale, be sure to coincide the yellow line with the dot by turning the MW/LW dial scale.

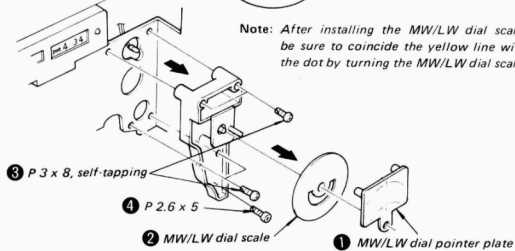

B Main Board Removal
on page 16.

C MW/LW Dial Cord Stringing
on page 20.

VFO Block Removal (2)

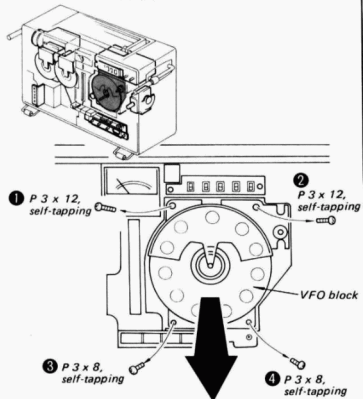

D SW Dial Scale Installation on page 18.

Mode Switch Board Removal

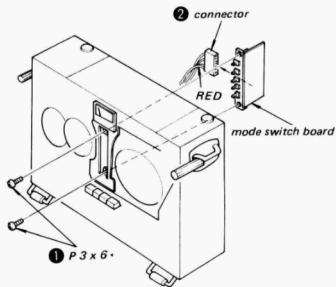

Side Panel (R) Removal

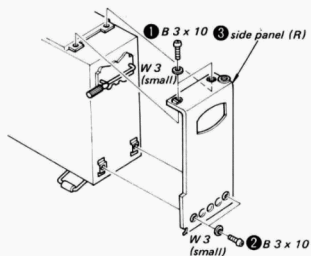

E Main Chassis Overturning (1) on page 12.

Antenna Tuning Block Removal

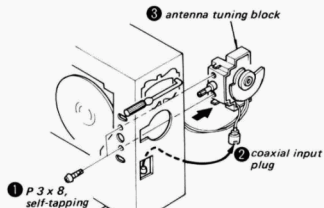

F Antenna Tuning Block Dial Cord Stringing on page 19.

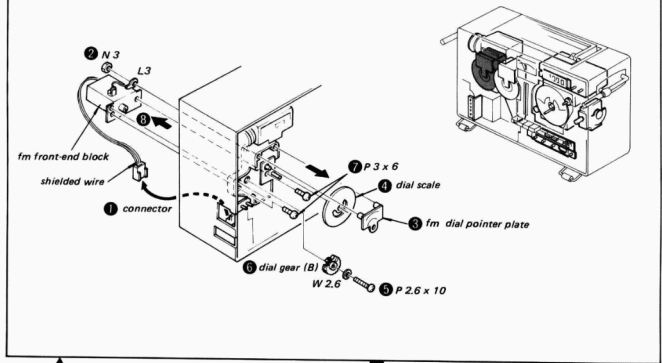
FM Front-end Block Removal

G FM Telescopic Antenna
Removal on page 15.

H FM Front-end Block
Installation on page 17.

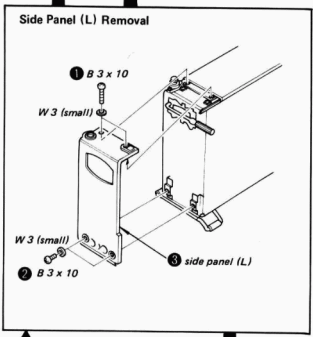
Side Panel (L) Removal

E Side Panel (R) Removal
on page 11.

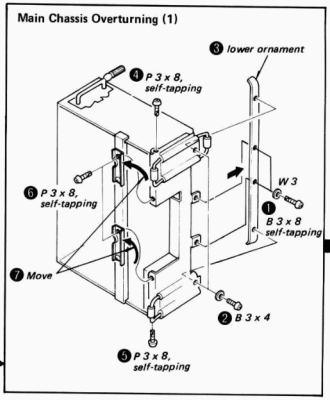
Main Chassis Overturning (1)

Counter Block Removal

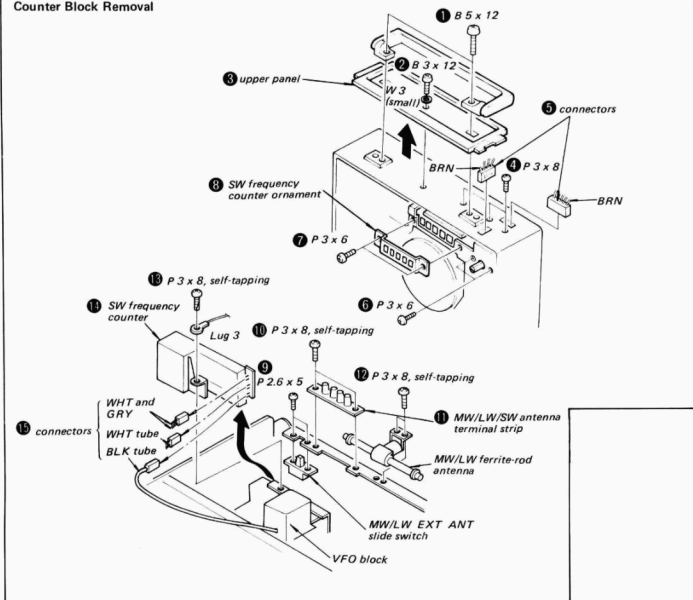

Main Chassis Overturning (2)

The set can be overturned as shown below.

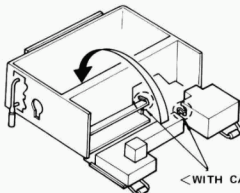

Power Supply Block Removal

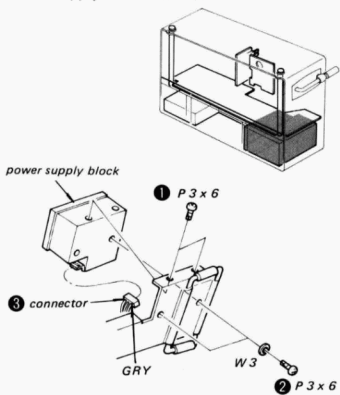

AC Input Connector Board and Power Supply Board Removal

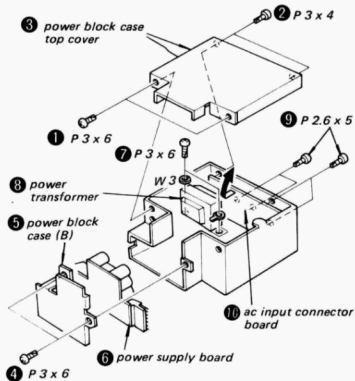

Synthesizer Block Removal

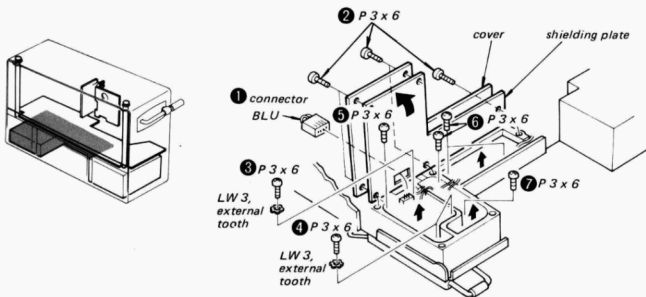

FM Telescopic Antenna Removal

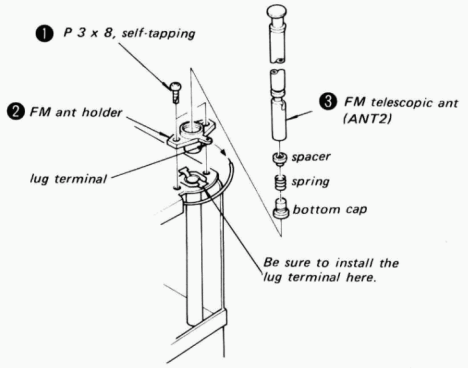
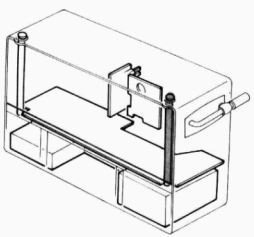

Ⓒ Side Panel (L) Removal on page 12.

Ⓐ Rear Panel Removal on page 7.

Ⓑ MW/LW Dial Block Removal on page 10.

SW Telescopic Antenna Removal

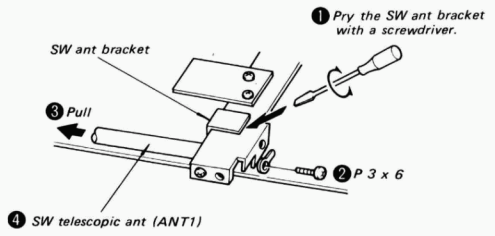
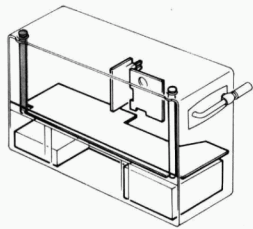

Main Board Removal (1)

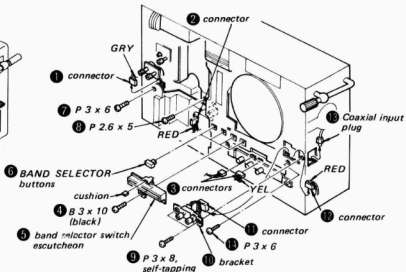
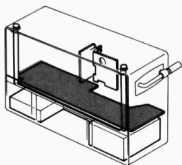

Main Board Removal (2)

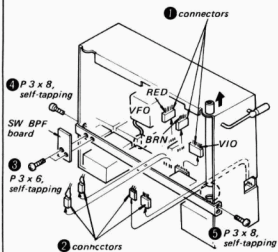

6 Remove the antenna guide pipe off.
 Note: The antenna guide pipe is fixed with locking compound.

Main Board Removal (3)

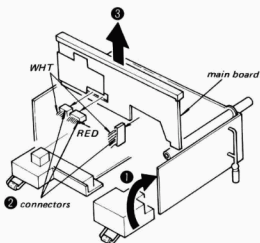

H FM Front-end Block Removal
on page 12.

FM Front-end Block Installation

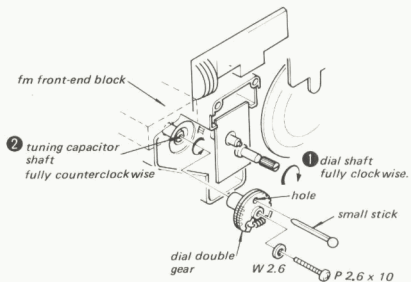
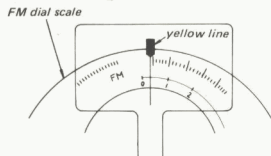
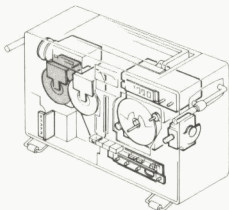

- 3** Fix the double gear with a small stick.
Take a small stick off after installing the double gear to the tuning capacitor shaft.
- 4** Turn and set the fm dial scale so that the first long line of the scale places one division ahead of the yellow line.

D VFO Block Removal (2)
on page 11.



SW Dial Scale Installation

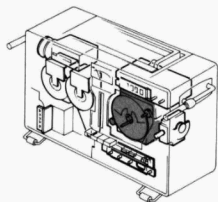

1 Install them slightly to the dial shaft.

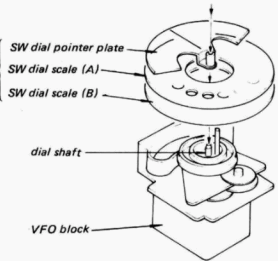

3 Turn the tuning shaft fully counterclockwise. Install the two kinds of dial scale and dial pointer plate so that the yellow line on the dial pointer plate points to "1010".

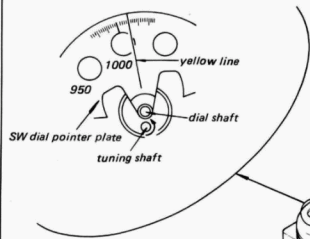

2 After turning the calibrator shaft fully clockwise, gear the SW dial pointer plate into the calibrator shaft on line mark.

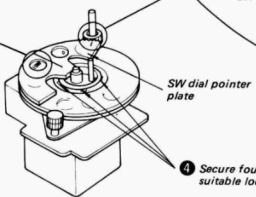
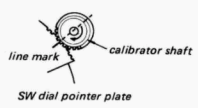

4 Secure four grooves with a suitable locking compound.

Ⓕ Antenna Tuning Block Removal
on page 11.

Antenna Tuning Block Dial Cord Stringing

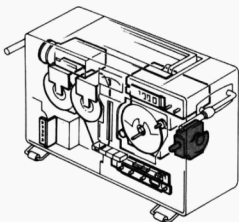

1. Dial Cord Preparation

- Crimp the eyelet.
- Secure the ties, eyelet and ferrite core with a suitable locking compound.

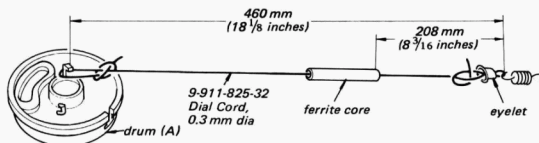

2. Dial Cord Stringing

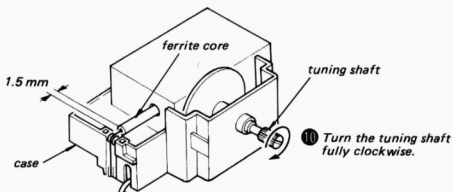
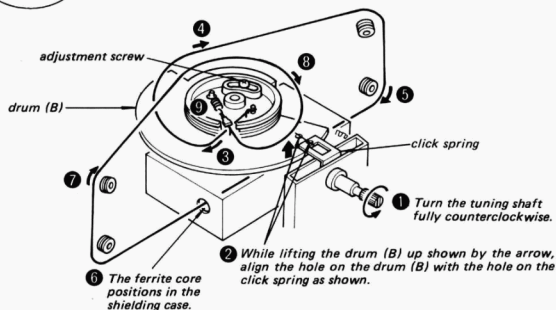

- 11 Loosen the adjustment screw and turn the drum (A) so that the clearance between the case and the ferrite core should be 1.5 mm.

© MW/LW Dial Block Removal
on page 10.

MW/LW Dial Cord Stringing

2. Dial Cord Stringing

1. Dial Cord Preparation

- Crimp the eyelets.
- Secure the dial cord and eyelets with a suitable locking compound.

9-911-825-42
Dial Cord, 0.5 mm dia

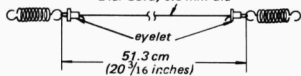

1 Turn this dial drum fully counterclockwise.

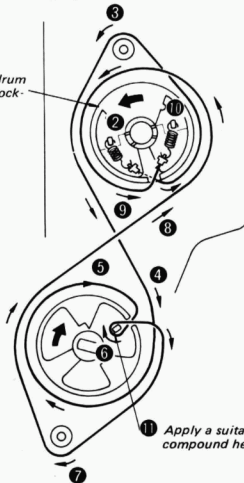

MW/LW Dial Block Installation

3 MW/LW dial pointer plate

1 pilot lamp

tuning shaft

2 MW/LW dial scale

4 Turn the tuning shaft fully clockwise and then coincide the yellow line with the dot by turning the MW/LW dial scale.



SECTION 3 ADJUSTMENTS

Test Equipment Required:

- FM rf signal generator
- AM rf signal generator
- FM sweep generator
- AM sweep generator
- marker generator
- frequency counter
(100 MHz, resolution ± 1 Hz)
- ac/dc VTVM
- rf VTVM
- oscilloscope
- detector (shown below)

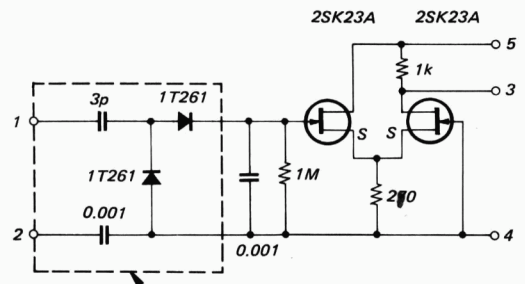

Wire this section shortest possible and connect capacitor leads directly to the test points shown in setup diagrams.

- **Note:** 1. Adjustments to the VFO can not be made by using generally available test equipment. When trouble is encountered to the VFO, replace the VFO Block.
Part No.: **A-3624-020-B**
- 2. Overturn the main chassis before the adjustments. Refer to pages 12 and 13.

3-1. AM IF AND BFO ADJUSTMENTS



Setting:

BAND SELECTOR switch: SW
 MODE switch: NARROW
 RF GAIN control: MIN

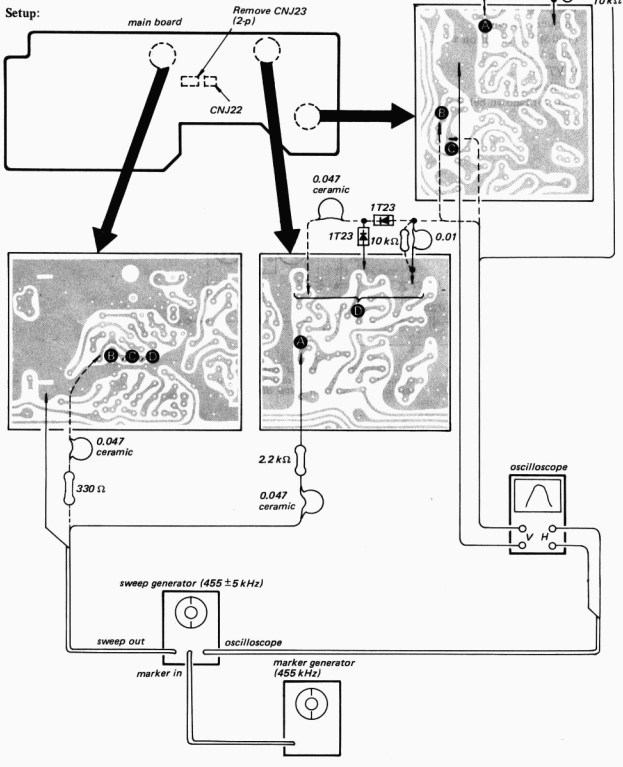
Setup:

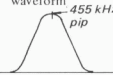

Procedure:

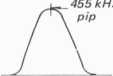
Adjust	Obtain
FL203 (Connect oscilloscope and sweep out to A .) (MODE switch: NORMAL) FL202 (MODE switch: NARROW)	Highest and widest waveform 
IFT202, IFT203 (Connect oscilloscope and sweep out to B .) (MODE switch: NORMAL)	Highest waveform 
IFT207 (MODE switch: LSB Connect oscilloscope to C .) Check: MODE switch: USB	A beat spike on the above waveform. Set the core at the center of rotation in which a spike appears on the waveform. Beat spike should move to the opposite slope and stays stably.
IFT202 (Connect oscilloscope and sweep out to D .) (MODE switch: NARROW)	Highest waveform 

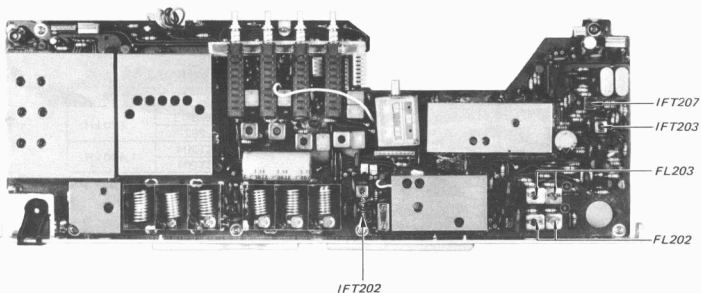

3-2. LW/MW FREQUENCY COVERAGE AND TRACKING ADJUSTMENTS

Setup:

AM rf signal generator
(400 Hz, 30% modulation)



VOM range:
0.5 ~ 1.5 V ac

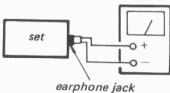

Adjust for maximum VOM reading.

A) LW

Setting:

- BAND SELECTOR switch: LW
- MODE switch: NORMAL
- VOLUME control: MAX
- TONE controls: MAX
- RF GAIN control: MAX/NORMAL

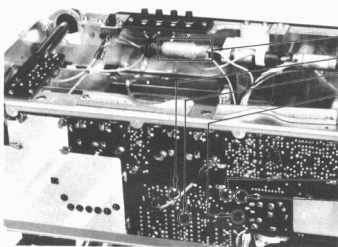

LW TRACKING	
L261-1	200 kHz
L263	
CT203	380 kHz
CT202	

Fix L261-1 with wax after the adjustment.

LW FREQUENCY COVERAGE	
L265 (146 kHz)	
CT205 (407 kHz)	

B) MW

Setting:

- BAND SELECT switch: MW
- MODE switch: NORMAL
- VOLUME control: MAX
- TONE controls: MAX
- RF GAIN control: MAX/NORMAL

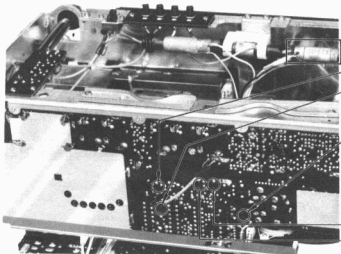

MW TRACKING	
L261-2	620 kHz
L262	
CT204	1,400 kHz
CT201	

Fix L261-2 with wax after the adjustment.

MW FREQUENCY COVERAGE	
L264 (520 kHz)	
CT206 (1,680 kHz)	

3-3. FM IF ALIGNMENT

Setting:

BAND SELECTOR switch:	FM
VOLUME control:	MAX
TONE controls:	MAX
MUTING switch:	OFF
AFC switch:	OFF

Setup:

FM rf signal generator
(400 Hz, ± 22.5 kHz deviation)

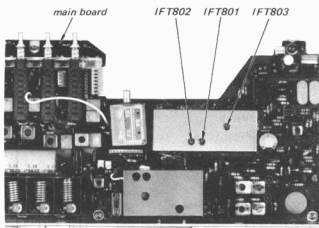
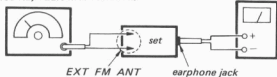

Procedure

Remove the FM front-end (Refer to page 12).

Signal Generator Frequency	Adjust	Obtain
10.7 MHz	IFT001 IFT801 IFT802	Maximum VOM ① reading.
10.7 MHz	IFT802	0 V VOM ② reading.
86.5 - 109.5 MHz (Tune the receiver in.)	IFT803	Maximum TUNING meter reading

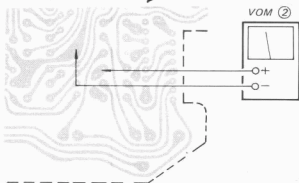
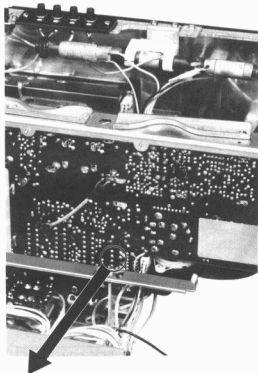
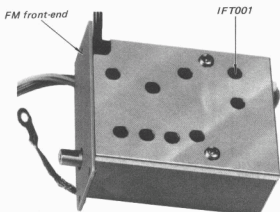

3-4. FM FREQUENCY COVERAGE AND TRACKING ADJUSTMENTS

Setting:

BAND SELECTOR switch: FM
 VOLUME control: MAX
 TONE controls: MAX
 MUTING switch: OFF
 AFC switch: OFF

Setup:

FM rf signal generator
 (400 Hz, ± 22.5 kHz deviation)

VOM range:
 0.5 ~ 1.5 V ac

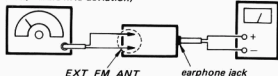

FM TRACKING					
109.5 MHz (108 MHz)			86.5 MHz (87.5 MHz)		
CT001	CT002	CT003	L001	L002	L003

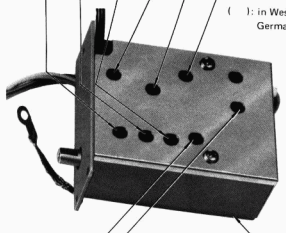

() : in West Germany

FM front-end

FM FREQUENCY COVERAGE	
L004	86.5 MHz (87.5 MHz)
CT004	109.5 MHz (108 MHz)

() : in West Germany

3-5. +5 V VOLTAGE ADJUSTMENT

Setting:

BAND SELECTOR switch: SW

Procedure:

1. Disconnect the fuse F2.
2. Install a 20 Ω , 8 W resistor on the conductor side as shown.
3. Adjust the value of R716 to obtain the specified voltage. Perform this adjustment on the conductor side.

Note: When the patterns are heated by a soldering iron, thermistor warms up. Cool off the components and circuit board at a time in selecting resistor.

4. Install the selected resistor on the component side.
5. Remove 20 Ω , 8 W resistor and reconnect the fuse.

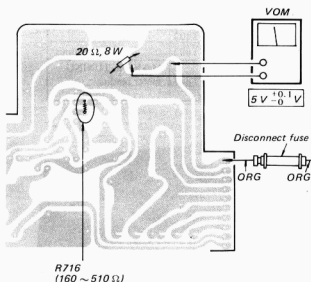

3-6. SW 1st IF ADJUSTMENT

Setting:

BAND SELECTOR switch:	SW
MODE switch:	NORMAL
VOLUME control:	center of rotation
TONE control:	center of rotation
NOISE BLANKER switch:	OFF

Setup:

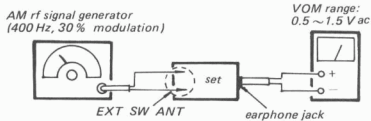

Procedure:

1. Set the AM rf signal generator to an appropriate frequency between 1.6 MHz and 30 MHz.
2. Tune the set in to the frequency set in step 1.
3. Adjust CTs207, 208, 209, 210, 211 and 212, and IFT201 for maximum VOM reading.

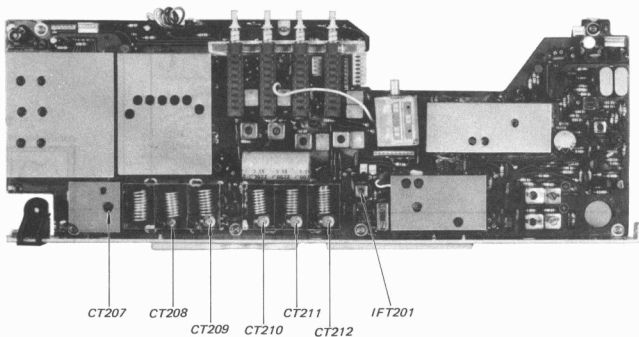

3-7. BANDPASS BLOCK ADJUSTMENT

Setup: main board

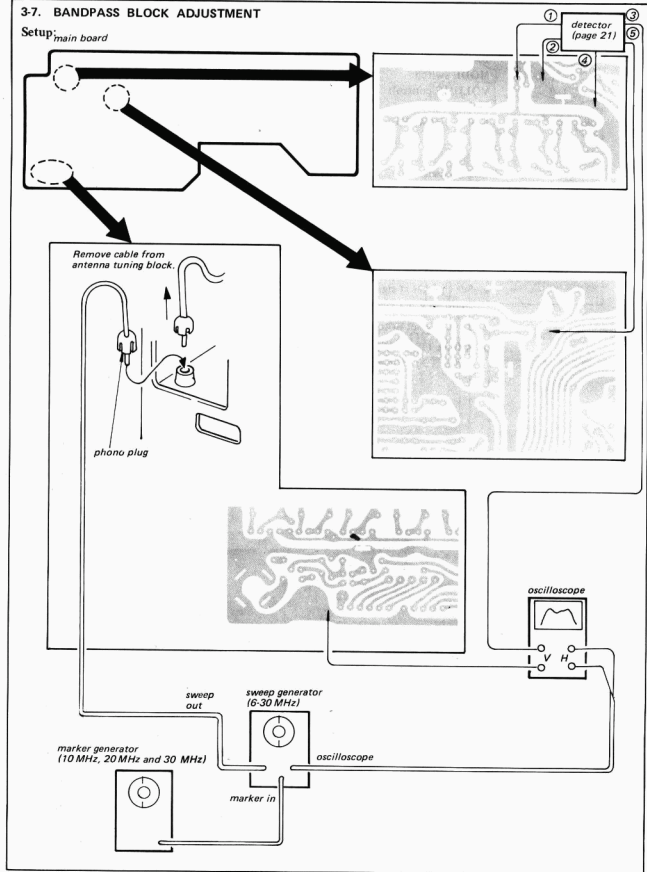

Setting:

BAND SELECTOR switch: SW
 VOLUME control: center of rotation
 TONE controls: center of rotation
 Marker Generator Frequencies: 10, 20 and 30 MHz

Procedure:

1. SW BAND SELECTOR switch: 10 MHz
 Sweep Generator Frequency: 6-30 MHz
2. Adjust L224, 225 and 228 to obtain a wave-form shown below.

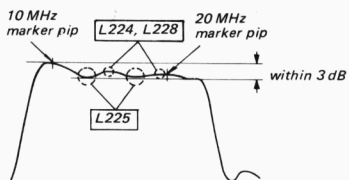

3. SW BAND SELECTOR switch: 20 MHz
 Sweep Generator Frequency: 15-35 MHz
4. Adjust L231, 232 and 235 to obtain a wave-form shown below.

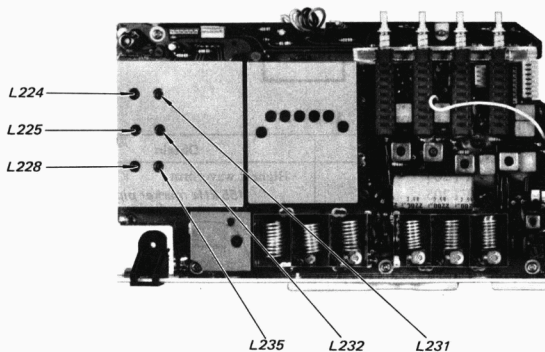
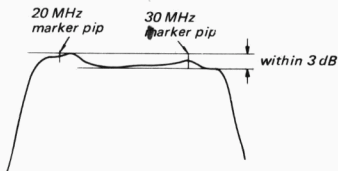

3-8. NOISE BLANKER ADJUSTMENT

Setting:

BAND SELECTOR switch: SW
 NOISE BLANKER switch: ON

Procedure:

1)

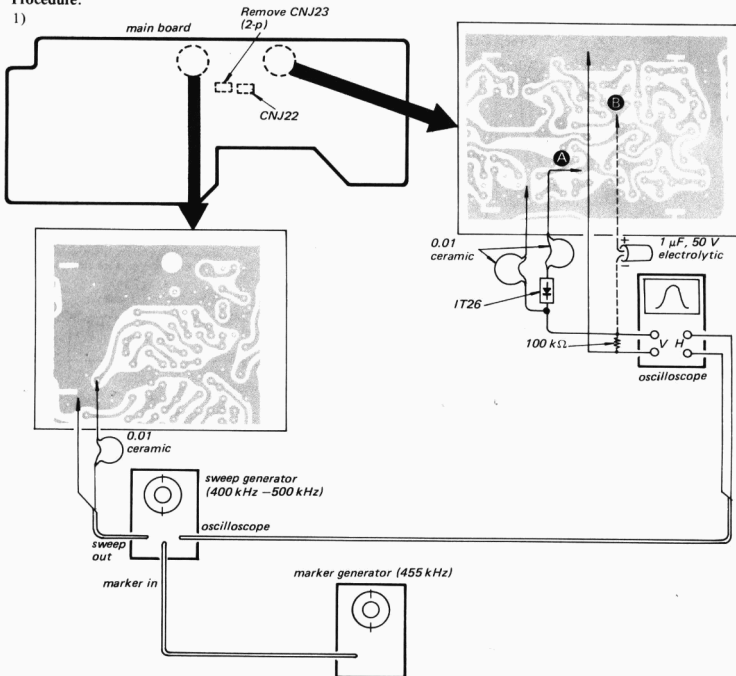

RF GAIN control: MIN

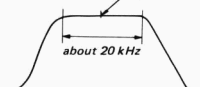
Adjust	Obtain
IFT204 IFT205 (Connect oscilloscope to A.)	Highest waveform 455 kHz marker pip 
IFT206 (Connect oscilloscope to B.)	

2) RF GAIN control: MAX/NORMAL

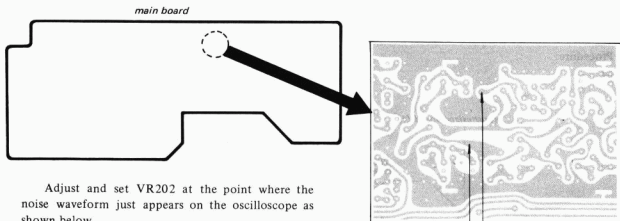

Adjust and set VR202 at the point where the noise waveform just appears on the oscilloscope as shown below.

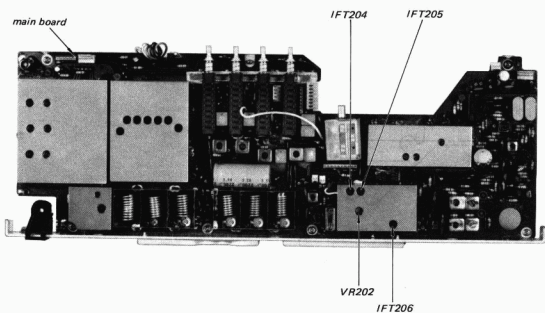
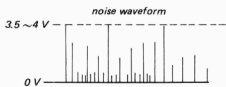

**3-9. 500 kHz REFERENCE OSCILLATOR
ADJUSTMENT**

Setting:

BAND SELECTOR switch: SW

Procedure:

1)

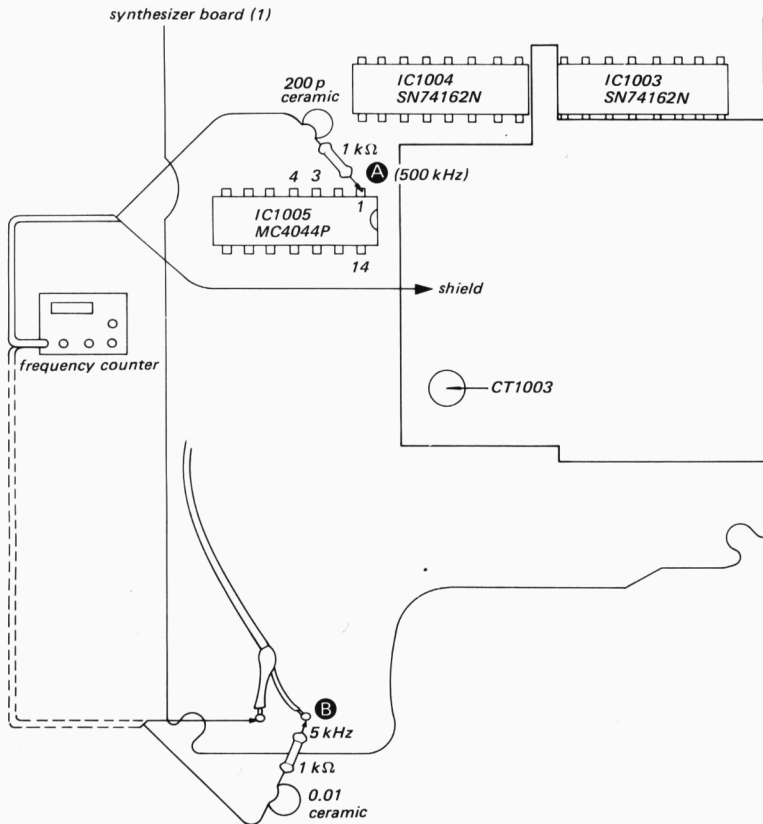

Adjust	Connect Frequency Counter to	Frequency Counter Reading
CT1003	A	500,000 Hz ± 1 Hz
(Check)	B	5,000 Hz

- 2) SW BAND SELECTOR switch: 29 MHz
 Unsolder a white wire.

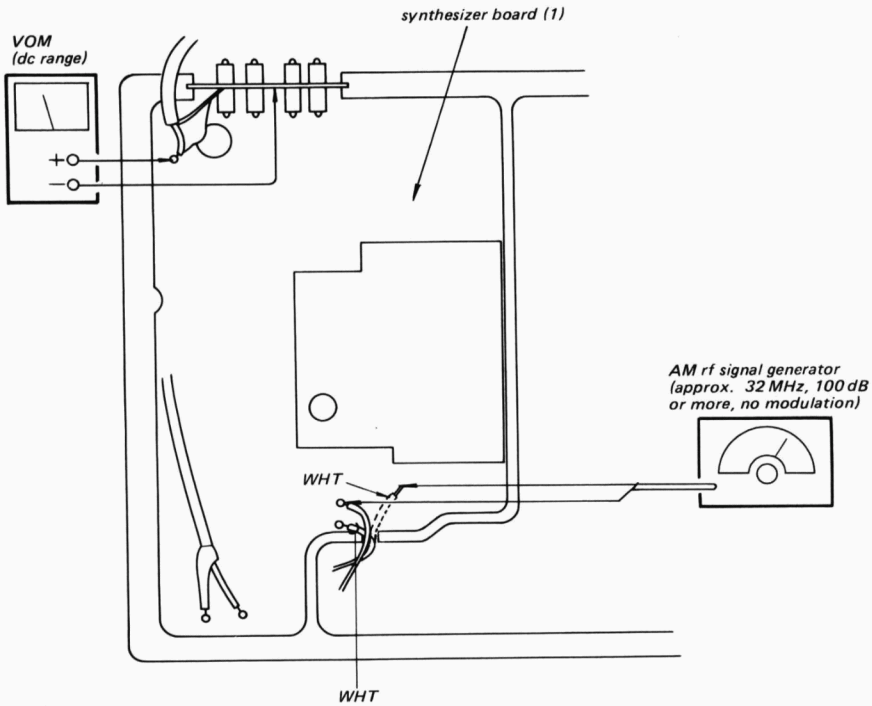

Adjust AM Rf Signal Generator Frequency	VOM Reading
around 32 MHz	0.7 V
below the frequency obtained above	6.3 V

3-10. SW 1st MIXER BALANCE ADJUSTMENT

Setting:

BAND SELECTOR switch: SW
 SW BAND SELECTOR switch: 22 MHz
 VOLUME control: center of rotation
 TONE controls: center of rotation
 MODE switch: AM NORMAL

Setup:

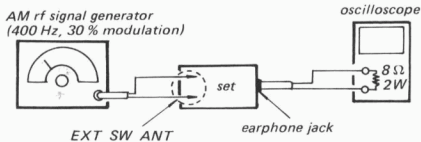

AM Rf Signal Generator Frequency	Tune the Set to	Adjust
22.57 MHz 70 dB	around 22.8 MHz to obtain a maximum waveform	VR201 to obtain a minimum waveform

VR201

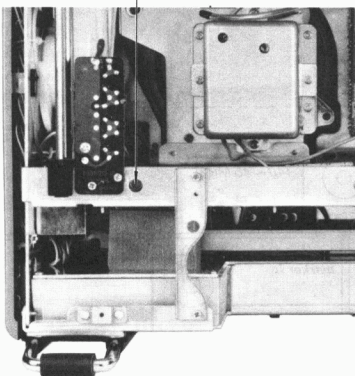

3-11. SYNTHESIZER SECTION ADJUSTMENTS

Setting:

BAND SELECTOR switch: SW

3-11-1. 42 MHz BPF ADJUSTMENT

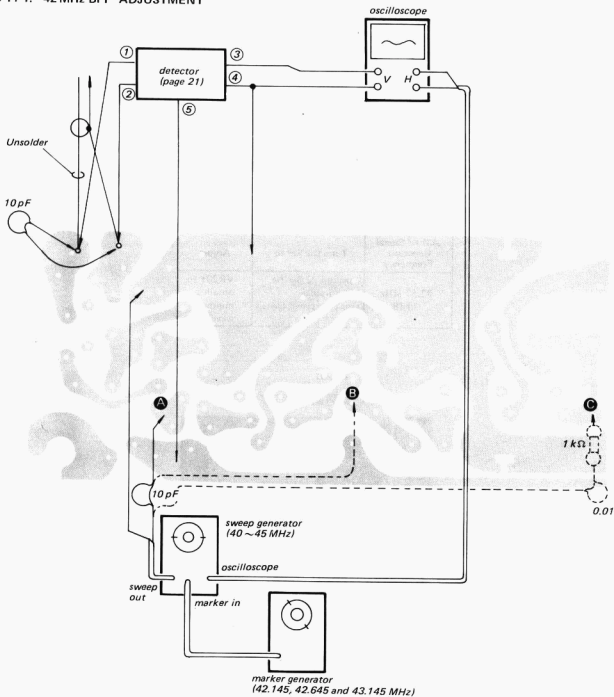

Procedure:

1. Turn CT1001 and stop the oscillation of 45.6 MHz. The 45.6 MHz pip disappears from the waveform on the oscilloscope.
2. Turn the cores, of L1003 through L1006 counterclockwise until they place on top of the coils.

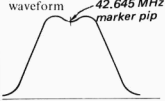
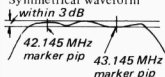
Connect Sweep Out to	Adjust	Obtain
A	L1008 L1009	 <p>Maximum double-humped waveform 42.645 MHz marker pip</p>
B	L1006 L1007	
C	L1003 L1004 L1005	
C (Reduce sweep out level)	L1003 through L1009 (fine adjust)	 <p>Symmetrical waveform within 3 dB 42.145 MHz marker pip 43.145 MHz marker pip</p>

L1009 L1008 L1007 L1006 L1005 L1004 L1003

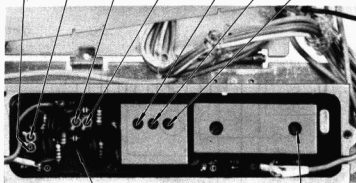

synthesizer board (3)

CT1001

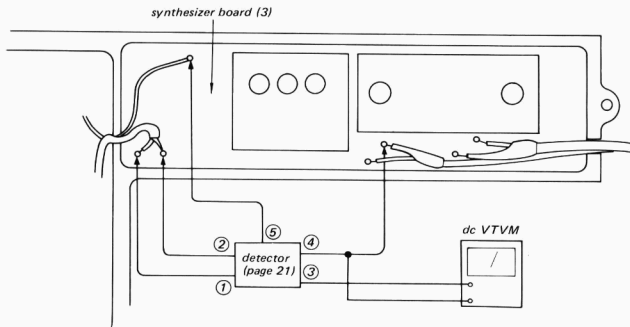

4. Turn the tuning dial throughout the range and confirm that the VTVM reading variation is within 3 dB. If not, perform steps 1 through 3.
5. Turn CT1001 and oscillate 45.6 MHz. 45.6 MHz pip appears on the waveform again.

3-11-2. 46-76 MHz BPF ADJUSTMENT

Setting:

BAND SELECTOR switch: SW

Setup:

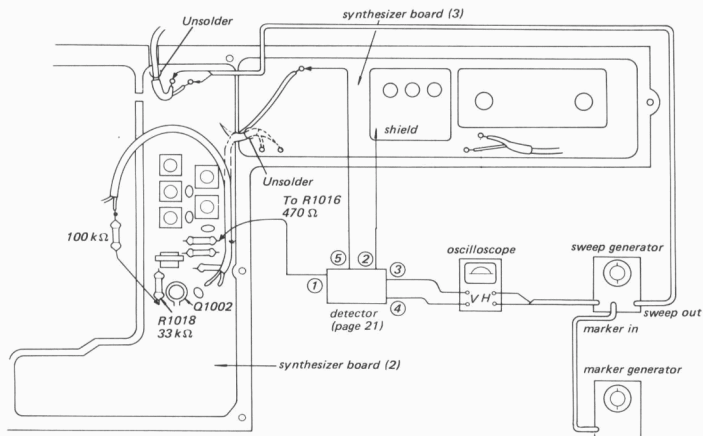

Procedure:

Adjust	Obtain
L1012 L1014 (ORG)	Maximum amplitude at 76 MHz.
L1013 (RED)	Maximum amplitude at 46 MHz.
L1011 L1015 (BLU)	Same amplitude at 46 MHz and 76 MHz.
Repeat all the above adjustment.	

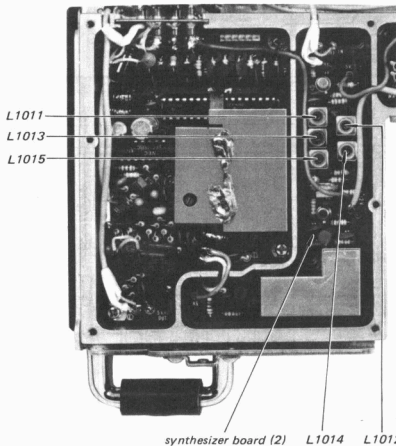
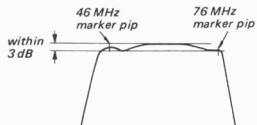

3-11-3. SW 2nd LOCAL OSCILLATOR ADJUSTMENT

Setting:

BAND SELECTOR switch: SW

Setup:

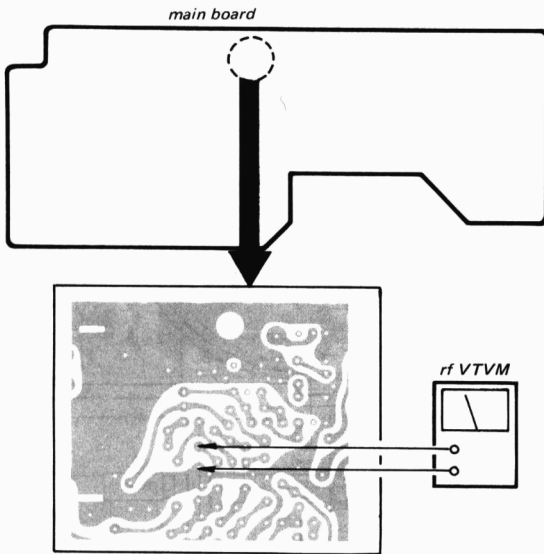

Procedure:

Adjust	Obtain
CT1001	Setting position.
CT1002	Minimum VTVM reading.

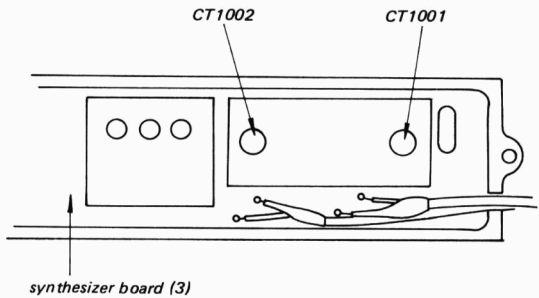

3-11-4. VCO ADJUSTMENT

Setting:

BAND SELECTOR switch: SW

Unsolder white wire and install a diode as shown.
Remove diode when instructed to do so.

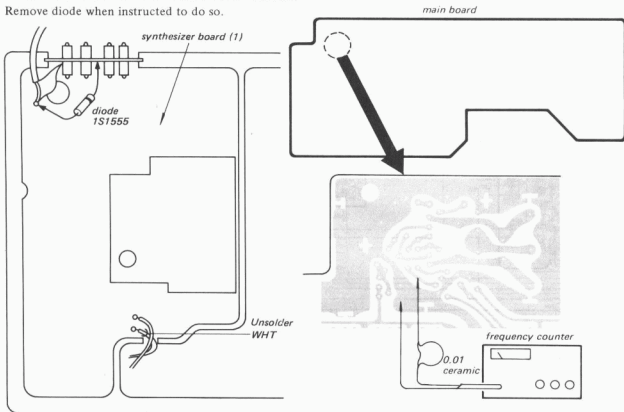

Step	SW BAND SELECTOR	Adjust	Frequency Counter Reading
1	2 MHz	L268	44.0 MHz
2	Remove diode 1S1555.		
3	3 MHz	L274	52.3 MHz
4	6 MHz	L269	56.1 MHz
5	10 MHz	L270	61.6 MHz
6	15 MHz	L273	66.4 MHz
7	20 MHz	L271	71.7 MHz
8	25 MHz	L272	76.8 MHz
9	Fix all coils with wax after the adjustment.		

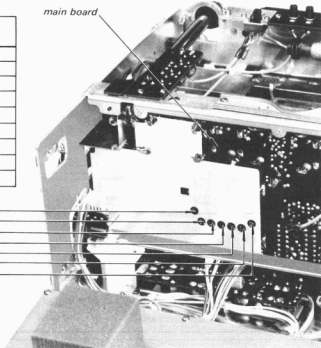

L268
L269
L270
L271
L272
L273
L274

3-11-5. SYNTHESIZER SECTION CHECKOUT
Setting:

BAND SELECTOR switch: SW
 SW BAND SELECTOR switch: 29 MHz

Setup:

AM rf signal generator
 (75.144 MHz, no modulation)

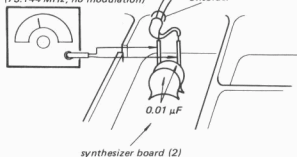

VOM (dc range)

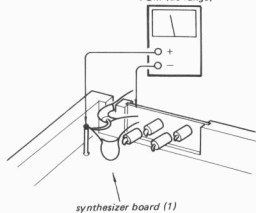
Procedure:

1. Turn the SW tuning knob and obtain a 29 MHz 999 kHz indication on the digital frequency indicator on the front panel.
2. Fine adjust the frequency of AM rf signal generator around 75.14 MHz.

AM Rf Signal Generator Frequency	VOM Indication
above 75.144 MHz	0.7 V
below 75.144 MHz	6.3 V

3-11-6. SW SPURIOUS BEAT ADJUSTMENT
Setting:

BAND SELECTOR switch: SW
 SW BAND SELECTOR switch: 29 MHz
 VOLUME control: MAX
 TONE controls: MAX
 RF GAIN control: MAX/NORMAL

Setup:

AM rf signal generator
 (no modulation)

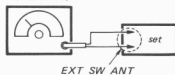
Procedure:

AM Rf Signal Generator Frequency	Adjust
approximately 29.352 MHz or 29.852 MHz	VR1001 for a minimum beat note

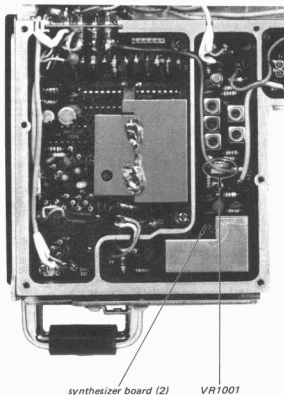

4.1. MOUNTING DIAGRAM

- Conductor Side -

SECTION 4
DIAGRAMS



Note:
 1. Color in 1 indicates order of starting from the
 direction of installation.
 2. Components are placed and through hole
 dimensions with position
 through hole

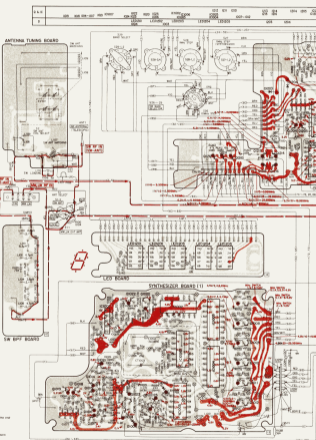

Note:

R210, 214, 218, 222, 228

R235, 238, 244, 321, 363, 836 flexible resistor

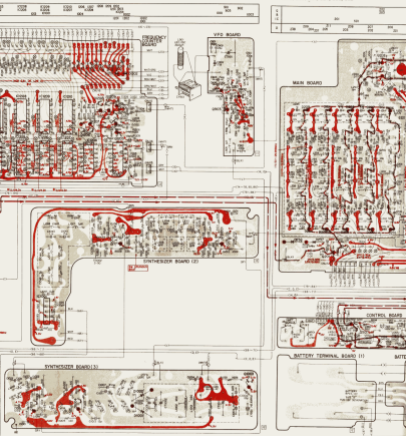

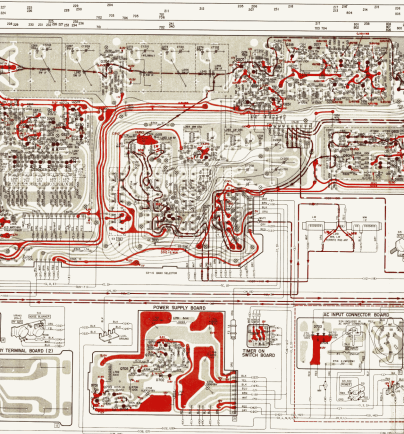

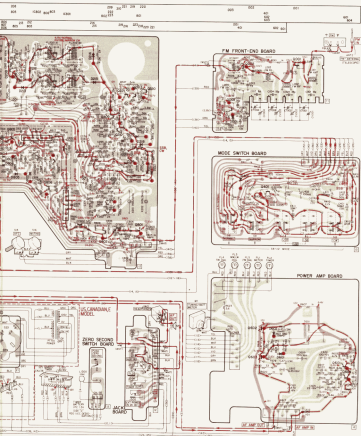

Note: The components identified by shading are critical for safety. Replace only with part number specified.

CRF-320 CR

4.2. SCHEMATIC DIAGRAM

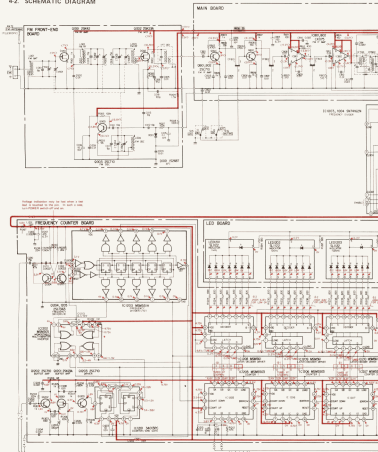

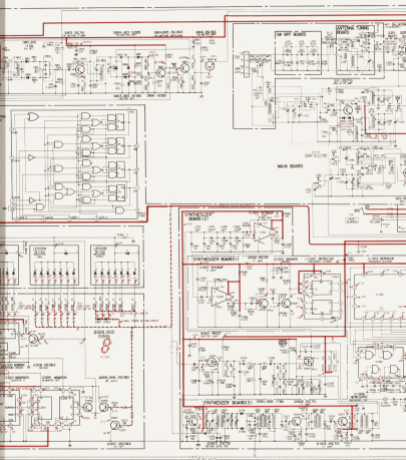

Note:

R210, 214, 216, 222, 226

R235, 239, 244, 321, 363, 836

Fusible resistor

CRF-320 CR

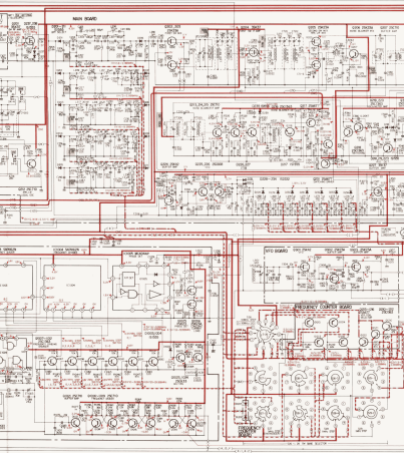

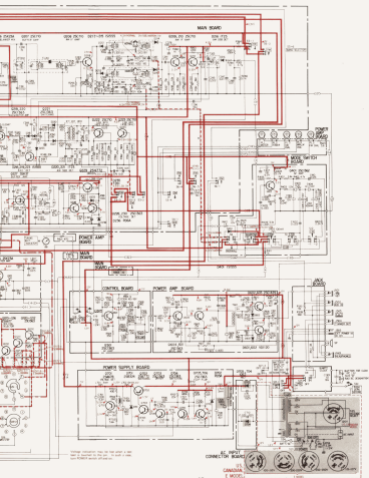

AEP model

4-3. SCHEMATIC DIAGRAM — Power Supply Section —

Note: The components identified by shading are critical for safety. Replace only with part number specified.

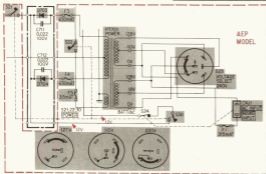

4-4. MOUNTING DIAGRAM

— Conductor Side —

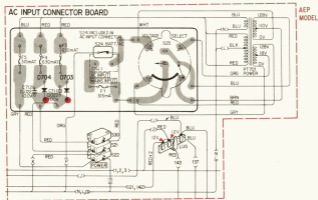

A B C D E

52.

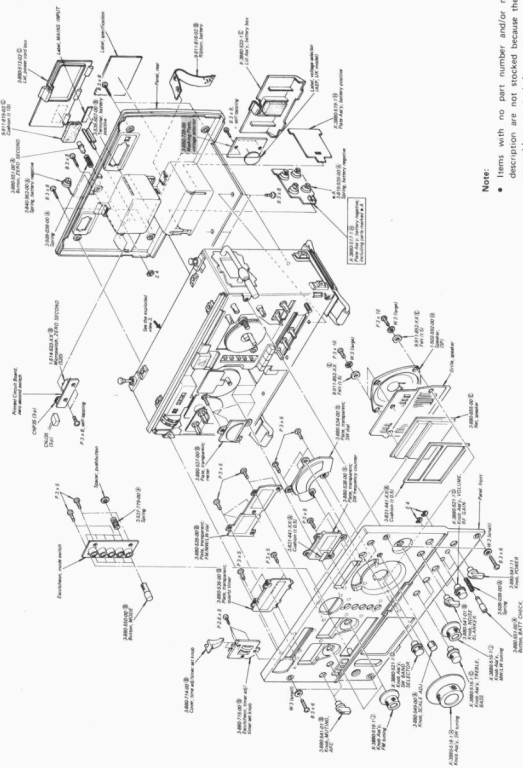

Note:

- Items with no part number and/or no description are not stocked because they are seldom required for routine service.
- All screws are Phillips (cross recess) type unless otherwise noted.
- (-) = slotted head
- Circled letters (A) to (Z) are applicable to European models only.

Note: The components identified by shading are critical for safety. Replace only with part number specified.

Replace only with part number specified.
Circled letters (A) to (Z) are applicable to European models only.

1 - 3 = slotted head
All screws are Phillips (cross recess) type unless otherwise noted.

A B C D E

5-3.

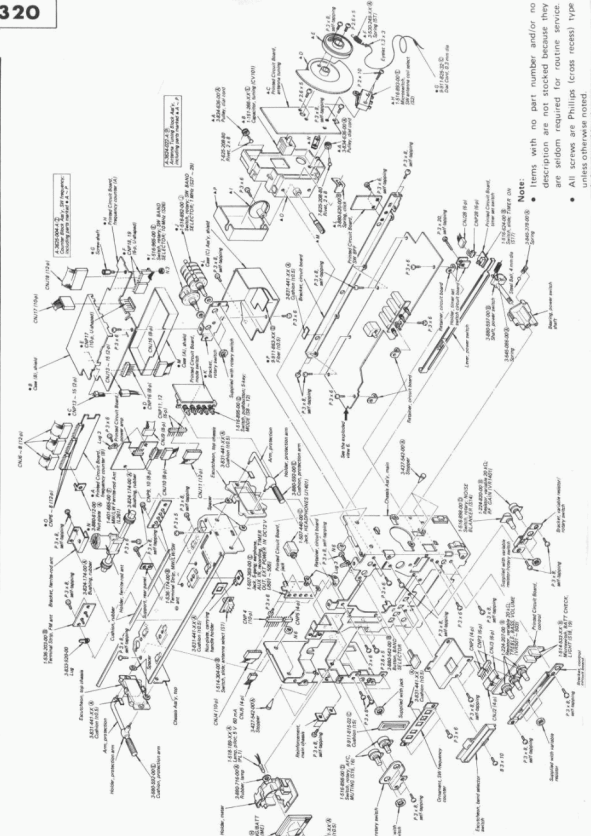

4

1

2

3

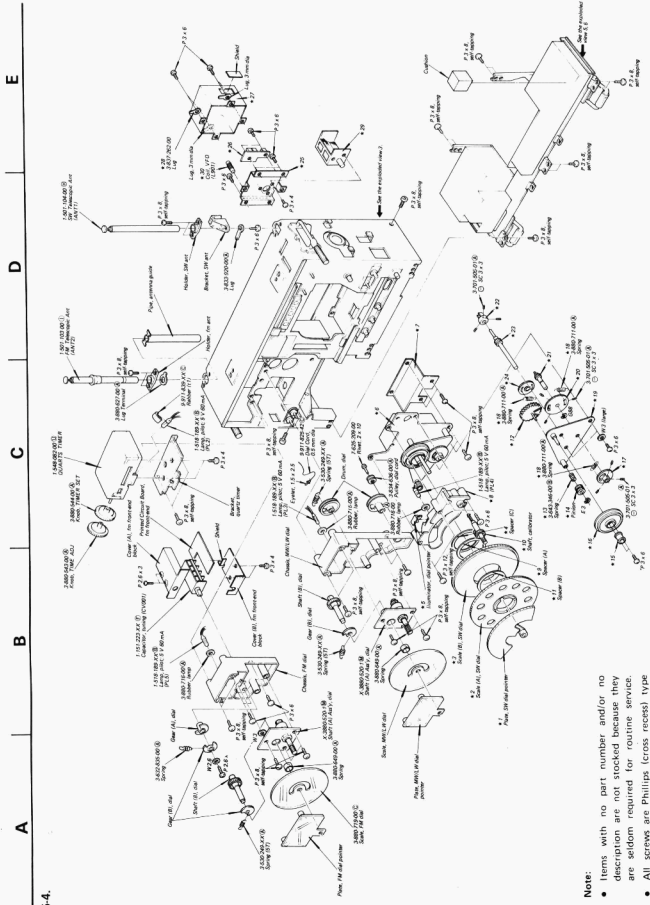

5-4.

Note:

- Items with no part number and/or no description are not stocked because they are seldom required for routine service.
- All screws are Phillips (cross recess) type unless otherwise noted.
- (LEET) shows the number of coils in spring.
- Circled letters (A) are applicable to European models only.

5.5.

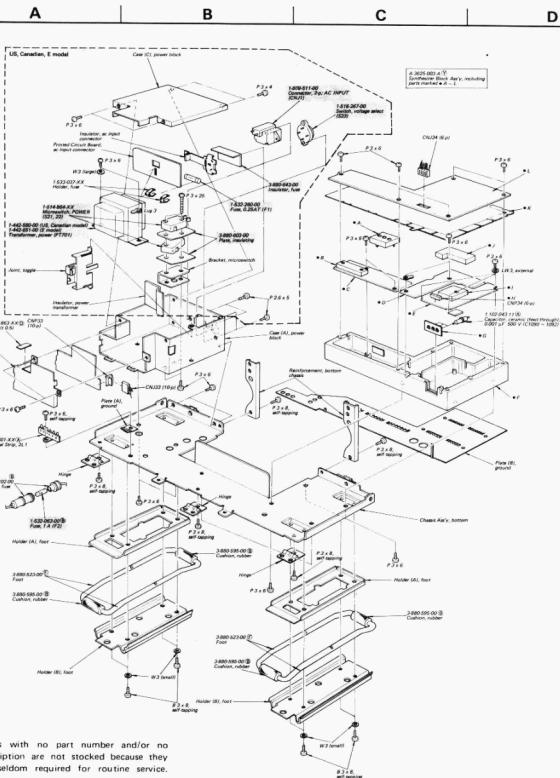

A

B

C

D

5-6.

1

2

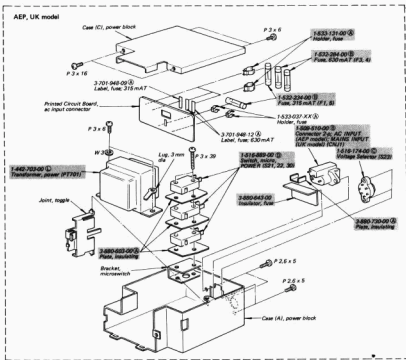

3

4

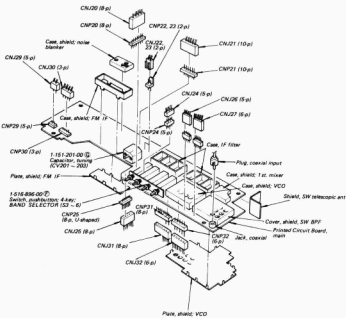

5

Note: The components identified by shading are critical for safety. Replace only with part number specified.

Note:

- Items with no part number and/or no description are not stocked because they are seldom required for routine service.
- All screws are Phillips (cross recess) type unless otherwise noted.
- (—) = slotted head
- Circled letters (A) to (Z) are applicable to European models only.

SECTION 6

ELECTRICAL PARTS LIST

Note: Circled letters (**A** to **Z**) are applicable to European models only.

<u>Ref. No.</u>	<u>Part No.</u>	<u>Description</u>
SEMICONDUCTORS		
Transistors		
Q001	C 2SK42	
Q002	C 2SK23A	
Q003	B 2SC710	
Q201	E 3SK37	
Q202, 203	C 2SK23A	
Q204	E 3SK37	
Q205, 206	C 2SK23A	
Q207 ~ 215	B 2SC710	
⇒ Q216	B 2SC634A	
⇒ Q217	C 2SA678	
⇒ Q218 ~ 221	B 2SC634A	
Q222, 223	B 2SC710	
Q224	C 2SK42	
Q225, 226	B 2SC668	
Q227	E 3SK37	
⇒ Q228	B 2SC634A	
Q229	C 2SA772	
⇒ Q230	B 2SC634A	
⇒ Q231	C 2SA678	
Q401	B 2SC632A	
⇒ Q501, 601	B 2SC634A	
Q602, 603	C 2SC1429	
⇒ Q604	B 2SC634A	
Q701	C 2SA678	
Q702	C 2SA772	
Q703 ~ 706	B 2SC634A	
Q801 ~ 803	B 2SC710	
⇒ Q804 ~ 806	B 2SC634A	
Q901	C 2SK42	
Q902, 903	C 2SK23A	
Q1001, 1002	E 3SK37	
Q1003, 1004	B 2SC710	
Q1006	C 2SK23A	
⇒ Q1007 ~ 1012	B 2SC634A	

<u>Ref. No.</u>	<u>Part No.</u>	<u>Description</u>
Q1013 ~ 1018	B 2SC710	
Q1019, 1020	C 2SC641K	
Q1021, 2022	B 2SC710	
⇒ Q1023, 1024	B 2SC634A	
Q1025, 1201	C 2SK23A	
Q1202, 1203	B 2SC710	
⇒ Q1204 ~ 1212	B 2SC634A	
⇒ Q1213 ~ 1216	C 2SA678	
ICs		
IC801, 802	D CX075A	
IC1001	D TA7060P	
⇒ IC1002	J 74S113DC	
IC1003, 1004	J SN74162N	
IC1005	K MC4044P	
⇒ IC1006	E HD74LS00P	
IC1007	D TA7060P	
IC1201	H 34013PC	
IC1202	E MSM505	
IC1203	K MSM551H	
IC1204	H MSM530	
IC1205 ~ 1207	L MSM5503	
IC1208 ~ 1210	K MSM561	
Diodes		
⇒ D001	B 1S351M	
D201 ~ 209	B 1S1555	
D211 ~ 215	B 1S1555	
⇒ D216	B 1T235	
D217 ~ 219	B 1S1555	
⇒ D220, 221	B 1T235	
D223, 225	B 1S1555	
D226, 227	C 1T18	
D228 ~ 234	B 1S2222	
D235	B 1T261	
D236	B RD6A	
D237 ~ 241	B 1S1555	
D401	B 1S1555	
D601, 602	A VD1120	
D701	B 2SB324	

⇒: Due to replacement parts, the descriptions are different from the diagrams.

Note: Circled letters (A) to (Z) are applicable to European models only.

<u>Ref. No.</u>	<u>Part No.</u>	<u>Description</u>
D702		(D) RD5A
D703, 704		(D) 10E2
D801, 802		(B) 1T261
D803 ~ 807		(B) 1S1555
D1001, 1002		(B) 1T261
D1003, 1004		(B) 1S1555
D1201 ~ 1204		(B) 1S1555
LED1201 ~ 1205		(H) SL 1122
Thermistors		
Th701	1-800-196-00	(A) S-300
Th1001	1-800-198-00	(A) S-1K
Th1002	1-800-194-00	(A) S-90
COILS		
L.001	1-425-929-00	(B) FM Antenna
L.002	1-425-930-00	(B) FM RF
L.003	1-425-929-00	(B) FM RF
L.004	1-405-527-00	(B) FM Osc
L.006	1-407-157-XX	(A) Microinductor, 10 μ H
L.201	1-407-178-XX	(A) Microinductor, 1 μ H
L.224	1-407-864-00	(B) RF BPF
L.225	1-407-865-00	(B) RF BPF
L.228	1-407-864-00	(B) RF BPF
L.231	1-407-862-00	(B) RF BPF
L.232	1-407-863-00	(B) RF BPF
L.235	1-407-862-00	(B) RF BPF
L.261	1-401-665-00	(F) MW/LW Ferrite-rod Antenna
L.262	1-425-911-00	(B) MW RF
L.263	1-425-444-00	(B) LW RF
L.264	1-405-717-00	(B) MW Osc
L.265	1-405-716-00	(B) LW Osc
L.266	1-417-053-00	(D) VCO Matching Transformer
L.267	1-407-178-XX	(A) Microinductor, 1 μ H
L.268	1-433-184-00	(B) VCO (1)

<u>Ref. No.</u>	<u>Part No.</u>	<u>Description</u>
L.269	1-433-185-00	(B) VCO (3)
L.270	1-433-188-00	(B) VCO (4)
L.271	1-433-189-00	(B) VCO (6)
L.272	1-433-190-00	(B) VCO (7)
L.273	1-433-186-00	(B) VCO (5)
L.274	1-433-187-00	(B) VCO (2)
L.275	1-425-912-00	(B) Mixing
L.282, 283	1-407-661-XX	(A) Microinductor, 470 μ H
L.287, 288	1-407-157-XX	(A) Microinductor, 10 μ H
L.289	1-407-661-XX	(A) Microinductor, 470 μ H
L.290	1-407-178-XX	(A) Microinductor, 1 μ H
L401 ~ 403	1-407-883-00	(C) Microinductor, 100 mH
L.701, 703	1-407-857-00	(D) Choke, 3 mH
L.702	1-407-884-00	(H) Choke, 6 mH
L.804	1-407-169-XX	(A) Microinductor, 100 μ H
L.1010	1-407-178-XX	(A) Microinductor, 1 μ H
L.1016	1-407-169-XX	(A) Microinductor, 100 μ H
L.1021 ~ 1023	1-407-856-00	(C) Choke, 1 mH
L.1025, 1026	1-407-169-XX	(A) Microinductor, 100 μ H
L.1201, 1202	1-407-856-00	(C) Choke, 1 mH
L.1203	1-407-175-XX	(A) Microinductor, 330 μ H
L.1300	1-407-856-00	(C) Choke, 1 mH
TRANSFORMERS		
FL201	1-403-165-00	(C) Ceramic Filter
FL202A, B	1-403-888-00	Mechanical Filter
FL203A, B	1-404-024-00	Mechanical Filter
IFT001	1-404-031-00	(B) FM IFT
IFT202	1-404-023-00	(B) AM IFT
IFT203	1-404-152-00	(B) AM IFT
IFT204 ~ 206	1-404-023-00	(B) AM IFT
IFT207	1-459-153-00	(B) BFO
IFT801	1-403-959-00	(B) FM Discriminator
IFT802	1-403-953-00	(B) FM Discriminator
IFT803	1-403-243-00	(B) FM IFT
PT701	1-442-580-00	Power (US, Canadian model)
	1-442-651-00	Power (E model)
	1-442-703-00	(L) Power (AEP, UK model)
T601	1-423-140-XX	(C) Input

Note: The components identified by shading are critical for safety. Replace only with part number specified.

Note: Circled letters (A) to (Z) are applicable to European models only.

<u>Ref. No.</u>	<u>Part No.</u>	<u>Description</u>	<u>Ref. No.</u>	<u>Part No.</u>	<u>Description</u>
CAPACITORS					
All capacitors are in μF and of ceramic unless otherwise noted.					
(p = μF , elect = electrolytic)					
50 or less working volts are omitted except for electrolytic type.					
C001	1-102-947-11	(A) 10 p	C218	1-107-075-11	(A) 39 p silvered mica
C002	1-161-013-11	(A) 0.01 (boundary layer)	C219	1-107-086-11	(A) 110 p silvered mica
C003, 004	1-102-951-11	(A) 15 p	C220	1-107-072-11	(A) 30 p silvered mica
C005	1-161-013-11	(A) 0.01 (boundary layer)	C221	1-107-086-11	(A) 110 p silvered mica
C006	1-102-972-11	(A) 91 p	C222	1-107-075-11	(A) 39 p silvered mica
C009	1-161-013-11	(A) 0.01 (boundary layer)	C223	1-121-651-11	(A) 10 16 V elect
C011, 012	1-102-947-11	(A) 10 p	C224	1-107-078-11	(A) 51 p silvered mica
C013	1-102-663-11	(A) 8 p	C225	1-161-013-11	(A) 0.01 (boundary layer)
C014	1-161-013-11	(A) 0.01 (boundary layer)	C226	1-107-074-11	(A) 36 p silvered mica
C015	1-127-019-11	(B) 0.1 10 V solid aluminum	C227	1-161-013-11	(A) 0.01 (boundary layer)
C016	1-121-651-11	(A) 10 16 V elect	C228	1-107-067-11	(A) 18 p silvered mica
C017	1-102-712-11	(A) 6 p	C229	1-107-081-11	(A) 68 p silvered mica
C018	1-102-975-11	(A) 100 p	C230	1-107-066-11	(A) 16 p silvered mica
C100	1-103-733-11	(A) 2200 p 50 V polystyrol	C231	1-107-081-11	(A) 68 p silvered mica
C101	1-103-729-11	(A) 0.0015 50 V polystyrol	C232	1-107-067-11	(A) 18 p silvered mica
C102	1-103-728-11	(A) 0.0013 50 V polystyrol	C233	1-107-071-11	(A) 27 p silvered mica
C103	1-107-082-11	(A) 75 p silvered mica	C234	1-121-651-11	(A) 10 16 V elect
C105	1-101-882-11	(A) 51 p	C235	1-161-013-11	(A) 0.01 (boundary layer)
C106	1-102-946-11	(A) 9 p	C236	1-102-507-11	(A) 9 p
C107	1-102-975-11	(A) 100 p	C237	1-161-013-11	(A) 0.01 (boundary layer)
C201 ~ 203	1-101-118-11	(A) 0.01	C238	1-102-511-11	(A) 13 p
C204	1-101-361-11	(A) 150 p	C239	1-102-516-11	(A) 27 p
C205	1-107-082-11	(A) 75 p silvered mica	C240	1-102-510-11	(A) 12 p
C206	1-107-068-11	(A) 20 p silvered mica	C241	1-102-516-11	(A) 27 p
C207 ~ 209	1-161-013-11	(A) 0.01 (boundary layer)	C242	1-102-511-11	(A) 13 p
C210	1-102-979-11	(A) 240 p	C243	1-102-501-11	(A) 1 p
C211	1-107-081-11	(A) 68 p silvered mica	C244	1-121-651-11	(A) 10 16 V elect
C212	1-107-102-11	(A) 5 p silvered mica	C245	1-161-013-11	(A) 0.01 (boundary layer)
C213	1-101-367-11	(A) 160 p	C246	1-102-505-11	(A) 6 p
C214	1-121-651-11	(A) 10 16 V elect	C247	1-161-013-11	(A) 0.01 (boundary layer)
C215	1-161-013-11	(A) 0.01 (boundary layer)	C248	1-102-864-11	(A) 5 p
C216	1-107-079-11	(A) 56 p silvered mica	C249	1-102-514-11	(A) 22 p
C217	1-161-013-11	(A) 0.01 (boundary layer)	C250	1-102-504-11	(A) 4 p
			C251	1-102-514-11	(A) 22 p
			C252	1-102-864-11	(A) 5 p
			C254	1-121-651-11	(A) 10 16 V elect
			C255	1-161-013-11	(A) 0.01 (boundary layer)
			C260 ~ 263	1-101-923-11	0.01

Note: Circled letters (A to Z) are applicable to European models only.

<u>Ref. No.</u>	<u>Part No.</u>	<u>Description</u>	<u>Ref. No.</u>	<u>Part No.</u>	<u>Description</u>
C264	1-107-077-11 (A) 47 p	silvered mica	C315	1-108-242-12 (A) 0.022	mylar
C265	1-102-125-11 (A) 0.0047		C316, 317	1-101-923-11 (A) 0.01	
C266	1-107-079-11 (A) 56 p	silvered mica	C318	1-121-413-11 (A) 100	6.3 V elect
C267	1-107-078-11 (A) 51 p	silvered mica	C319	1-102-125-11 (A) 0.0047	
C268	1-102-074-11 (A) 0.001		C320	1-101-923-11 (A) 0.01	
C269	1-101-923-11 (A) 0.01		C321	1-102-503-11 (A) 3 p	
C270, 271	1-102-121-11 (A) 0.0022		C322	1-102-877-11 (A) 33 p	
C272	1-107-078-11 (A) 51 p	silvered mica	C323	1-102-526-11 (A) 75 p	
C273, 274	1-107-079-11 (A) 56 p	silvered mica	C324	1-101-999-11 (A) 10 p	
C275	1-161-017-11 (A) 0.022	(boundary layer)	C325	1-102-755-11 (A) 43 p	
C276	1-107-233-11 (A) 430 p	silvered mica	C326	1-102-743-11 (A) 3 p	
C277	1-102-125-11 (A) 0.0047		C327	1-102-121-11 (A) 0.0022	
C278	1-107-078-11 (A) 51 p	silvered mica	C328	1-102-112-11 (A) 330 p	
C279	1-161-017-11 (A) 0.022	(boundary layer)	C329 ~ 335	1-102-125-11 (A) 0.0047	
C280	1-102-944-11 (A) 7 p		C336	1-101-923-11 (A) 0.01	
C281, 282	1-101-924-11 (A) 0.022		C337	1-102-505-11 (A) 6 p	
C283	1-101-923-11 (A) 0.01		C338	1-102-074-11 (A) 0.001	
C284	1-108-239-12 (A) 0.01	mylar	C339	1-102-121-11 (A) 0.0022	
C285 ~ 290	1-101-924-11 (A) 0.022		C340	1-102-074-11 (A) 0.001	
C291	1-101-923-11 (A) 0.01		C341	1-121-413-11 (A) 100	6.3 V elect
C292	1-161-017-11 (A) 0.022	(boundary layer)	C345	1-101-924-11 (A) 0.022	
C293	1-101-923-11 (A) 0.01		C346	1-107-235-11 (A) 510 p	silvered mica
C294	1-108-242-12 (A) 0.022	mylar	C347	1-101-923-11 (A) 0.01	
C295	1-101-924-11 (A) 0.022		C350	1-107-071-11 (A) 27 p	silvered mica
C296	1-107-079-11 (A) 56 p	silvered mica	C351	1-101-924-11 (A) 0.022	
C297, 298	1-108-239-12 (A) 0.01	mylar	C352	1-101-923-11 (A) 0.01	
C299	1-107-235-11 (A) 510 p	silvered mica	C353	1-108-242-12 (A) 0.022	mylar
C302	1-108-563-12 (B) 0.0022	mylar	C354, 355	1-101-923-11 (A) 0.01	
C303	1-101-924-11 (A) 0.022		C356, 357	1-108-242-12 (A) 0.022	mylar
C304	1-121-391-11 (A) 1	50 V elect	C358	1-101-924-11 (A) 0.022	
C305, 306	1-108-244-12 (A) 0.033	mylar	C359	1-121-651-11 (A) 10	16 V elect
C307	1-102-942-11 (A) 5 p		C360, 361	1-101-924-11 (A) 0.022	
C308	1-102-949-11 (A) 12 p		C362	1-102-832-11 (A) 330 p	
C309	1-102-679-11 (A) 12 p		C363	1-121-651-11 10	16 V elect
C310	1-103-714-11 (A) 360 p	50 V polystyrol	C364	1-102-114-11 (A) 470 p	
C312	1-102-964-11 (A) 36 p		C365	1-127-022-11 (B) 0.47	10 V solid aluminum
C313, 314	1-102-947-11 (A) 10 p		C366	1-101-923-11 (A) 0.01	
			C367	1-127-023-11 (B) 1	10 V solid aluminum

Note: Circled letters (A to Z) are applicable to European models only.

Ref. No.	Part No.	Description
C368	1-107-102-11 (A) 5 p	silvered mica
C369, 370	1-101-923-11 (A) 0.01	
C371	1-108-239-12 (A) 0.01	mylar
C372	1-108-242-12 (A) 0.022	mylar
C373	1-101-924-11 (A) 0.022	
C374	1-107-085-11 (A) 100 p	silvered mica
C375, 376	1-101-923-11 (A) 0.01	
C377	1-123-070-11 (C) 2200	16 V elect
C378	1-121-943-11 (B) 1000	10 V elect
C379	1-102-121-11 (A) 0.0022	
C380	1-108-234-12 (A) 0.0047	mylar
C381	1-101-923-11 (A) 0.01	
C383, 384	1-101-924-11 (A) 0.022	
C385	1-102-934-11 (A) 1 p	
C386	1-102-935-11 (A) 2 p	
C387	1-161-013-11 (A) 0.01	(boundary layer)
C388	1-102-121-11 (A) 0.0022	
C390	1-131-205-21 (B) 2.2	10 V tantalum
C391	1-101-923-11 (A) 0.01	
C401	1-127-018-11 (B) 0.047	10 V solid aluminum
C402	1-108-244-12 (A) 0.033	mylar
C403	1-121-951-11 (A) 0.47	50 V elect
C404	1-127-019-11 (B) 0.1	10 V solid aluminum
C405	1-127-022-11 (B) 0.47	10 V solid aluminum
C406	1-127-020-11 (B) 0.22	10 V solid aluminum
C407	1-121-415-11 (B) 100	16 V elect
C408	1-102-099-11 (A) 1500 p	
C409	1-108-244-12 (A) 0.033	mylar
C410	1-161-015-11 (A) 0.015	(boundary layer)
C411	1-161-021-11 (A) 0.047	(boundary layer)
C412	1-127-019-11 (B) 0.1	10 V solid aluminum
C501	1-127-377-11 (B) 0.22	16 V solid aluminum
C502	1-101-918-11 (A) 0.001	
C503	1-161-013-11 (A) 0.01	(boundary layer)
C504	1-121-415-11 (B) 100	16 V elect
C505	1-127-377-11 (B) 0.22	16 V solid aluminum
C506	1-127-018-11 (B) 0.047	10 V solid aluminum
C507	1-127-378-11 (B) 0.68	10 V solid aluminum

Ref. No.	Part No.	Description
C508	1-161-024-11 (A) 0.082	(boundary layer)
C509	1-127-378-11 (B) 0.68	10 V solid aluminum
C601	1-121-415-11 (B) 100	16 V elect
C602	1-127-377-11 (B) 0.22	16 V solid aluminum
C603	1-102-975-11 (A) 100 p	
C604	1-102-074-11 (A) 0.001	
C605	1-121-479-11 (A) 22	16 V elect
C606	1-161-015-11 (A) 0.015	(boundary layer)
C607	1-161-019-11 (A) 0.033	(boundary layer)
C608, 609	1-121-521-11 (B) 330	16 V elect
C610	1-127-203-11 (B) 0.33	16 V solid aluminum
C611, 612	1-121-939-11 (B) 470	16 V elect
C613	1-102-123-11 (A) 0.0033	
C614	1-102-119-11 (A) 0.0015	
C701	1-123-078-11 (B) 2200	6.3 V elect
C702	1-121-944-11 (E) 1000	16 V elect
C704	1-108-232-12 (A) 0.0033	mylar
C705	1-101-923-11 (A) 0.01	
C706	1-108-234-12 (A) 0.0047	mylar
C707	1-107-093-11 (A) 220 p	silvered mica
C708	1-121-944-11 (E) 1000	16 V elect
C709, 710	1-121-660-11 (B) 2200	16 V elect
C711, 712	1-108-381-12 (A) 0.022	100 V mylar
C801 ~ 804	1-101-923-11 (A) 0.01	
C805	1-121-413-11 (A) 100	6.3 V elect
C806 ~ 809	1-101-923-11 (A) 0.01	
C810	1-101-924-11 (A) 0.022	
C811, 812	1-101-923-11 (A) 0.01	
C813	1-101-924-11 (A) 0.022	
C814	1-108-234-12 (A) 0.0047	mylar
C815	1-121-651-11 (A) 10	16 V elect
C816	1-108-228-12 (A) 0.0015	mylar
C817	1-127-022-11 (B) 0.47	10 V solid aluminum
C819	1-102-962-11 (A) 30 p	
C820 ~ 822	1-101-923-11 (A) 0.01	
C823	1-102-940-11 (A) 3 p	
C824	1-127-024-11 (B) 2.2	10 V solid aluminum
C825	1-102-940-11 (A) 3 p	

Note: The components identified by shading are critical for safety. Replace only with part number specified.

Note: Circled letters (A) to (Z) are applicable to European models only.

Ref. No.	Part No.	Description
C826, 827	1-101-923-11 (A) 0.01	
C829	1-127-019-11 (B) 0.1	10 V solid aluminum
C830	1-101-923-11 (A) 0.01	
C832	1-101-924-11 (A) 0.022	
C834	1-101-923-11 (A) 0.01	
C835	1-121-982-11 (A) 470	6.3 V elect
C836	1-121-426-11 (B) 470	16 V elect
C901	1-102-648-11 (A) 43 p	
C902	1-102-672-11 (A) 24 p	
C904	1-107-068-11 (A) 20 p	silvered mica
C905	1-107-089-11 (A) 150 p	silvered mica
C906	1-107-092-11 (A) 200 p	silvered mica
C907	1-108-279-12 (A) 0.015	mylar
C908	1-107-099-11 (A) 2 p	silvered mica
C909	1-107-098-11 (A) 1 p	silvered mica
C910	1-108-279-12 (A) 0.015	mylar
C911	1-107-085-11 (A) 100 p	silvered mica
C912	1-107-085-11 (A) 100 p	silvered mica
C913, 914	1-108-279-12 (A) 0.015	mylar
C1001	1-101-923-11 (A) 0.01	
C1002	1-102-953-11 (A) 18 p	
C1003	1-101-923-11 (A) 0.01	
C1004, 1005	1-107-087-11 (A) 120 p	silvered mica
C1006	1-101-923-11 (A) 0.01	
C1007~1009	1-107-097-11 (A) 330 p	silvered mica
C1010~1012	1-107-087-11 (A) 120 p	silvered mica
C1013	1-102-949-11 (A) 12 p	
C1014	1-101-923-11 (A) 0.01	
C1015	1-101-924-11 (A) 0.022	
C1016, 1017	1-107-087-11 (A) 120 p	silvered mica
C1018	1-102-949-11 (A) 12 p	
C1019	1-101-923-11 (A) 0.01	
C1020	1-101-924-11 (A) 0.022	
C1021, 1022	1-107-087-11 (A) 120 p	silvered mica
C1023	1-101-924-11 (A) 0.022	
C1024~1026	1-101-923-11 (A) 0.01	
C1027	1-102-119-11 (A) 0.0015	

Ref. No.	Part No.	Description
C1028	1-101-923-11 (A) 0.01	
C1029	1-101-924-11 (A) 0.022	
C1030	1-102-506-11 (A) 7 p	
C1031	1-102-503-11 (A) 3 p	
C1032	1-102-512-11 (A) 16 p	
C1033	1-102-503-11 (A) 3 p	
C1034	1-102-505-11 (A) 6 p	
C1035~1037	1-101-923-11 (A) 0.01	
C1038, 1039	1-101-924-11 (A) 0.022	
C1040	1-102-864-11 (A) 5 p	
C1041	1-102-951-11 (A) 15 p	
C1042	1-102-504-11 (A) 4 p	
C1043	1-102-948-11 (A) 11 p	
C1044	1-102-943-11 (A) 6 p	
C1045	1-102-949-11 (A) 12 p	
C1046	1-102-503-11 (A) 3 p	
C1047	1-161-013-11 (A) 0.01	(boundary layer)
C1049	1-101-924-11 (A) 0.022	
C1055	1-101-923-11 (A) 0.01	
C1059	1-102-121-11 (A) 0.0022	
C1060~1065	1-101-923-11 (A) 0.01	
C1066	1-102-977-11 (A) 200 p	
C1067	1-102-973-11 (A) 100 p	
C1068	1-161-021-11 (A) 0.047	(boundary layer)
C1069	1-107-070-11 (A) 24 p	silvered mica
C1070	1-102-409-11 (C) 30 p	
C1071, 1072	1-102-121-11 (A) 0.0022	
C1073	1-121-413-11 (A) 100	6.3 V elect
C1074	1-121-352-11 (A) 47	10 V elect
C1075, 1076	1-131-236-21 (B) 1	25 V tantalum
C1077	1-102-121-11 (A) 0.0022	
C1078	1-101-880-11 (A) 47 p	
C1079, 1080	1-107-093-11 (A) 220 p	silvered mica
C1081	1-102-963-11 (A) 33 p	
C1082, 1083	1-103-714-11 (A) 360 p	polystyrol
C1084	1-102-963-11 (A) 33 p	
C1085, 1086	1-108-555-12 (B) 0.001	mylar
C1090~1092	1-102-043-11 (A) 0.001	500 V (feed-through)

Note: Circled letters (A to Z) are applicable to European models only.

Ref. No.	Part No.	Description
C1093	1-101-798-11 (A) 0.2	(boundary layer)
C1094	1-121-391-11 (A) 1	50 V elect
C1095	1-101-880-11 (A) 47 p	
C1096, 1097	1-121-414-11 (A) 100	10 V elect
C1098	1-107-063-11 (A) 12 p	silvered mica
C1099	1-161-013-11 (A) 0.01	(boundary layer)
C1100	1-102-944-11 (A) 7 p	
C1101	1-102-953-11 (A) 18 p	
C1102	1-102-977-11 (A) 200 p	
C1103	1-101-923-11 (A) 0.01	
C1104	1-101-924-11 (A) 0.022	
C1105	1-127-019-11 (B) 0.1	10 V solid aluminum
C1106	1-101-919-11 (A) 0.0022	
C1107	1-102-043-11 (A) 0.001	500 V (feed-through)
C1108	1-102-934-11 (A) 1 p	
C1201	1-121-424-11 (B) 470	6.3 V elect
C1202	1-102-121-11 (A) 0.0022	
C1203	1-131-193-21 (B) 10	10 V tantalum
C1204~1206	1-101-924-11 (A) 0.022	
C1207, 1208	1-101-923-11 (A) 0.01	
C1209	1-101-924-11 (A) 0.022	
C1210	1-101-890-11 (A) 75 p	
C1211, 1212	1-108-563-12 (B) 0.0022	mylar
C1213	1-127-019-11 (B) 0.1	10 V solid aluminum
C1214, 1215	1-101-798-11 (A) 0.2	(boundary layer)
C1301	1-121-651-11 (A) 10	16 V elect
CT1001 ~ 1003	1-141-171-00 (B) Trimmer	
CT201~206	1-141-142-XX (B) Trimmer	
CT207	1-141-138-XX (B) Trimmer	
CT208	1-141-174-00 (B) Trimmer	
CT209~212	1-141-138-XX (B) Trimmer	
CV001	1-151-223-XX (F) Tuning	
CV101	1-151-266-21 (E) Tuning	
CV201~203	1-151-201-00 (G) Tuning	

Ref. No. Part No. Description

RESISTORS

All resistors are in ohms. Regular-type 1/4W carbon and composition resistors are omitted. Check schematic diagram for resistance values. k = 1000, M = 1000 k

R210, 214	1-212-879-11 (A) 82	1/4W	fusible
R218, 222			
R226			
R235, 239	1-212-881-11 (A) 100	1/4W	fusible
R244, 321			
R363	1-212-857-11 (A) 10	1/4W	fusible
R501	1-206-475-11 (A) 33	2W	metal-oxide
R551	1-244-837-11 (A) 33	1/2W	carbon
R618, 619	1-207-459-11 (A) 0.47	1/2W	wirewound
R714	1-202-723-11 (A) 2.2M	1/2W	composition
R836	1-212-869-11 (A) 33	1/4W	fusible

VR201	1-224-642-XX (B) 1 k, adjustable; first mixer balance
VR202	1-224-644-XX (B) 4.7k, adjustable; blank level
VR501~503	1-224-207-00 (B) 20k, variable; TREBLE, BASS, VOLUME
VR1001	1-221-378-00 (B) 200k, adjustable; SW spurious beat
VR1401	1-224-820-00 (B) 20k, variable; RF GAIN

SWITCHES

S1	1-514-304-00 (B) Slide, antenna select
S2	1-516-893-00 (E) Micro, SW antenna coil select
S3 ~ 6	1-516-896-00 (F) Pushbutton, 4-key; BAND SELECTOR
S8 ~ 12	1-516-895-00 (G) Pushbutton, 5-key; MODE
S14 ~ 16	1-516-898-00 (D) Rotary, NOISE BLANKER, AFC, MUTING
S17	1-516-624-00 (B) Slide, TIMER ON
S18 ~ 20	1-514-533-XX (B) Micro, BATT CHECK, LIGHT, ZERO SECOND
S21, 22	1-514-864-XX (B) Micro, POWER (US, Canadian, E model)
S23	1-516-889-00 (D) Micro, POWER (AEP, UK model)
	1-516-267-00 (D) Voltage Select (US, Canadian, E model)
S24	1-516-174-00 (D) Voltage Select (AEP, UK model)
	Included in ac input connector
S25	Included in QUARTS TIMER
S26	1-516-965-00 (E) Rotary, SW BAND SELECTOR (10 MHz)
S27 ~ 29	1-516-892-00 (J) Rotary, SW BAND SELECTOR (1 MHz)
S30	1-516-889-00 (D) Micro, POWER (AEP, UK model)

Note: The components identified by shading are critical for safety. Replace only with part number specified.

Note: Circled letters (A to Z) are applicable to European models only.

<u>Ref. No.</u>	<u>Part No.</u>	<u>Description</u>
MISCELLANEOUS		
ANT1	1-501-104-00	(H) SW Telescopic Antenna
ANT2	1-501-103-00	(I) FM Telescopic Antenna
CF801 ~ 803	1-527-184-00	(B) Filter, ceramic (10.7 MHz)
CNJ1	1-509-511-00	Connector, 2-p; AC INPUT including S24 (US, Canadian, E model)
	1-509-510-00	(B) Connector, 2-p; AC INPUT (AEP model)/MAINS INPUT (UK model); including S24
CR801	1-231-202-00	(B) Encapsulated Component
F1	1-532-260-XX	Fuse, 0.25 A (US, Canadian, E model)
	1-532-234-00	(B) Fuse, 315 mA (AEP, UK model)
F2	1-532-063-00	(B) Fuse, 1 A
F3, 4	1-532-284-00	(B) Fuse, 630 mA (AEP, UK model)
F5	1-532-234-00	(B) Fuse, 315 mA (AEP, UK model)
J501 ~ 505	1-507-369-00	(E) Jack, 5-unit; earphone, AUX IN, recording, TIMER OUT, EXT POWER IN DC 12 V

<u>Ref. No.</u>	<u>Part No.</u>	<u>Description</u>
J1401	1-507-440-00	(C) Jack, HEADPHONES
ME	1-520-249-00	(H) Meter, TUNING/BATT INDICATOR
PL1 ~ 5	1-518-189-XX	(B) Lamp, pilot; 5 V 60 mA; meter, timer, dial
SP	1-502-592-00	(H) Speaker
X201	1-527-270-00	(I) Crystal
X202	1-527-271-00	(I) Crystal
X1001	1-527-272-00	(H) Crystal
X1002	1-527-269-00	(K) Crystal
	1-533-037-XX	(A) Holder, fuse
	1-533-102-00	(B) Holder, fuse
	1-533-131-00	(A) Holder, fuse (AEP, UK model)
	1-536-174-00	(B) Terminal Strip, MW/LW/SW antenna
	1-536-203-00	(B) Terminal Strip, FM antenna
	1-536-401-XX	(A) Terminal Strip, 2L1
	1-548-082-21	(U) QUARTZ TIMER

ACCESSORIES & PACKING MATERIALS

<u>Part No.</u>	<u>Description</u>	<u>Part No.</u>	<u>Description</u>
X-3701-032-0	Card Ass'y, warranty (US model)	3-880-697-00	(C) Bag, polyethylene
1-504-059-11	(C) Earphone, ME-20H	3-880-699-00	(C) Cushion
1-526-565-00	Adaptor, ac plug (E model)	3-880-700-00	(C) Cushion
1-534-830-00	Cord, power; DK-33H (E model)	3-880-701-00	(C) Cushion
1-534-840-XX	(E) Cord, power (AEP model)	3-880-702-00	(C) Cushion
1-534-867-00	Cord, power; DK-35 (US model)	3-880-721-00	(F) Carton
1-551-002-XX	Cord, power (Canadian model)	3-993-063-13	(B) Book, SHORT WAVE GUIDE
1-551-218-00	(E) Cord, power; DK-50 (UK model)	3-993-131-00	(I) Chart, world time zone
3-701-625-00	(A) Bag, polyethylene	3-995-735-11	(K) Manual, instruction (E, AEP, UK model)
3-701-632-00	(A) Bag, polyethylene	3-995-735-23	Manual, instruction (US, Canadian model)
3-793-956-31	(B) Card, warranty (Canadian model)		

Note: The components identified by shading are critical for safety. Replace only with part number specified.

K4XL's **BAMA**

This manual is provided **FREE OF CHARGE** from the "BoatAnchor Manual Archive" as a service to the Boatanchor community.

It was uploaded by someone who wanted to help you repair and maintain your equipment.

If you paid anyone other than BAMA for this manual, you paid someone who is making a profit from the free labor of others without asking their permission.

You may pass on copies of this manual to anyone who needs it. But do it without charge.

Thousands of files are available without charge from BAMA. Visit us at <http://bama.sbc.edu>